







Presse USB singola - Single USB socket

P.37

-  **Materiale - Material**
ABS
-  **Colore - Color**
Nero - Black
-  **Pezzi confezione - Package items**
5 pezzi - pieces
-  **Volume confezione - Package volume**
0,8 dm³ - 130 X 110 X 60 mm
-  **Peso confezione - Package weight**
200 g

SPO Ricambi - Spare parts

 Accessori - Accessories

 Temp. di esercizio - Working temp.

LEX **Normative - Norms**
R107.8; R118.3; FMVSS 302; ISO 3795; REACH; ROHS; CMR.
More info on page E2-E3 and website on "Directives and regulations" area.

NEW



P.37

Cod.	Tipo USB - USB type	Volt
66440	A + C	12/24
66450	C + C	12/24

Sezione tecnica - Technical section

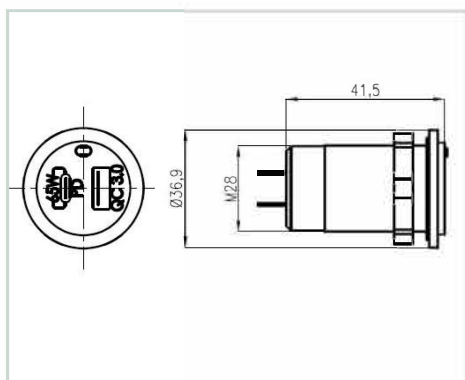

E