



2026 / 2027

Original Equipment for the aftermarket

Spiegelsysteme für Nutzfahrzeuge
Mirror systems for commercial vehicles

I - II - III - IV - V - VI
Spiegelklasse
mirror class

Material des Spiegelgehäuses
material of the mirror body

Durchmesser der Spiegelstange
oder Art der Montage
diameter of the mirror bracket
or way of mounting

Fahrzeugtyp / Baujahr
vehicle model / year of production

EG-Prüf-Nummer
CE-number

Spiegeltyp
mirror type

Beschreibung des Artikels
description of the item

Abmessungen
dimensions

Originalnummer des Fahrzeugherstellers
OE number of the vehicle manufacturer



392-1

II e1 03★0024
II (E) 02 0925

Truck II

ABS

Ø 28 mm

	Bestandteil description	24V 01.13	mm	OE
51.3921.224H			399 x 207 x 137	81.63730-6482
51.3923.224H			339 x 222 x 138	81.63730-6487
51.3921.223H			399 x 207 x 137	81.63730-6480
51.3923.223D			399 x 222 x 138	81.63730-6485
15.3920.840H			379 x 166 x 47	81.63733-6049
51.3922.224H			399 x 222 x 138	81.63730-6483
51.3924.224H			399 x 207 x 137	81.63730-6486
51.3922.223H			399 x 222 x 138	81.63730-6481
51.3922.223D				
51.3922.233H				
15.3920.840H				
11.3921				

20

B97/EEC

01/07

01/07 - 11/14

01/07 - 11/14

MEKRA Artikel-Nummer

grüner Hintergrund	Komplettsystem
grauer Hintergrund	Zubehör, im Lieferumfang des Komplettsystems
gelber Hintergrund	Zubehör, gesondert zu bestellen

MEKRA article number

green background	complete system
grey background	accessory, included in delivery of the complete system
yellow background	accessory, must be ordered separately

New Regulation
TGA
TGL
TGM





Inhalt index

Aufbau der MEKRA Artikelnummern		
Structure of the MEKRA article numbers		04
Verzeichnis der Spiegel-Typen		
Mirror type list		05
Liste aller MEKRA Artikel im Katalog		
List of all MEKRA-articles in this catalogue		06-08
Vergleichsliste nach OE - Nummern		
Cross-reference-table		08-17
Homologationsnummernliste		
List of homologation numbers		18-19
Fahrzeughersteller		
Manufacturer		18-79
	CITROEN	20-21
	DAF	22-29
	FIAT	30-31
	FORD	32-33
	IVECO	34-35
	MAN	36-53
	MERCEDES	54-69
	OPEL	70
	PEUGEOT	72-73
	RENAULT	74-77
	SCANIA	78-79
	VOLVO	80-84
	VOLKSWAGEN (VW)	85-89
	UNIVERSAL	90-105
Allgemeine Verkaufs- und Lieferbedingungen		
General terms and conditions of sale and delivery		106-107

9 stellig digit

04...	
08...	
09...	
10...	
11...	
13...	
14...	
15...	
20...	
39...	
40...	
51...	
53...	
55...	
56...	
58...	
59...	
61...	

3. - 5. Ziffer digit = Spiegeltyp mirror type

12 stellig digit

08...	
09...	
11...	
12...	
14...	
15...	
19...	
20...	
40...	
51...	
55...	
56...	
58...	
59...	
61...	

3. - 6. Ziffer digit = Spiegeltyp mirror type

z. B. / e. g. 59.5800.101H = Typ / type 580

59.2910.001.001 = Typ / type 291

59.1018.003.099 = Typ / type 1018



152 ASKB	92
224	84
248/2 A	103
249 K	63
249 L	63
250	80
251	38
252	80
253	54
254	54
260	36
265	37
266	37
266-1	37
270 A	105
271	50,99
271 A	103
276	50
277	52
278	51
279	35
281	62
289	92
291	100,101
300	91
320	36
340	36
341	36
348	23,76
349	63,85
349 TW	63,85
360	80
360-1	80
363	92
364	38
365-1	37
370	80
371	80
373	22,40
375	55
375 A	55
377	55,58



377-1	55,58
378	58
378 A	58
378-1	58
380-1	41
381-1	41
385	90
386	22,40
386-1	22
389	91
390	28,74,81
392	42
392-1	43
392-2	44
393-1	43
393-2	44
395	62
396	57,59
398	62
400	78
552	25
552-1	25,76,81,90,91
558	76
559	24,27
570	24
570 A	25
571	24
572	39,84
573	39,84
574	24
575	56
575 A	56
577	56
579	39,42,44,57,59
580	45
589	64,65,86,87
600	60
750	91
906	22
1000	29,75,82
1004	57,59,60
1005	25,27,78



1008	34,35
1009	94,95
1010	93
1012	60
1013	48,49,88,89
1016	104
1017	96
1018	98
1019	79
1020	47,78
1024	46
1025	25,76,84
1027	26
1033	74
1036	97
1036+1017	96
1038	93
1039	66,67,68,69
1041	53
1042	53
1043/1044	83
1047	77
1048	20,21,30,31 70,72,73
1049	32,33

MEKRA-Katalog-Artikel MEKRA-catalogue articles



04.0603.007.000	42,43,44	11.3910.120H	74	15.3731.470H	22,50,99	19.1048.004.099	20,21,30,70,72	40.3485.412H	23,76
08.1013.010.099	49,89	11.3910.200H	28,74,81	15.3752.470H	55,62	19.1048.005.099	20,21,30,70,72	40.3605.203H	80
08.1013.012.199	49,89	11.3921.110H	42,43	15.3771.174H	55,58,62	19.1048.006.099	20,21,30,70,72	40.3605.204F	80
08.1013.013.199	49,89	11.3921.120H	42,43	15.3774.410H	55,58	19.1049.001.099	32,33	40.3605.403H	80
08.1013.712.199	49,89	11.3921.400	43,44	15.3780.840H	58	19.1049.002.099	32,33	40.3640.222H	36,38
08.1013.713.199	49,89	11.3931.110H	43	15.3784.470H	58	19.1049.003.099	32,33	40.3640.322H	38
08.1024.124.099	45,46,47,53,78	11.3931.120H	43	15.3802.840H	41,92	19.1049.004.099	32,33	40.3640.422H	36,38
08.1039.001.099	67	11.5700.100H	24	15.3861.114H	22	19.1049.005.099	32,33	40.5725.212H	39
08.1039.002.099	67	11.5710.110H	24	15.3862.174H	22	19.1049.006.099	32,33	40.5725.412H	39,84
08.1039.005.099	67	11.5721.001.099	39,84	15.3900.840H	28,74,81	19.2790.011.099	35	40.5735.203H	39
08.1039.006.099	67	11.5731.001.099	39,84	15.3910.871H	75	19.2790.012.099	35	40.5735.403H	39,84
08.1039.011.099	67	11.5800.100H	45	15.3910.872H	75	19.2790.031.099	35	51.1009.001.099	95
08.1047.001.099	77	11.5800.200H	45	15.3911.871H	28,74,81	19.2790.032.099	35	51.1009.009.099	95
08.1047.002.099	77	11.9060.100H	22,27	15.3911.872H	28,74,81	19.2910.001.099	53,101	51.1009.017.099	94
08.1048.001.099	20,30,72	12.1005.001.099	27	15.3920.840H	43	19.2910.002.099	53,101	51.1009.021.099	94
08.1048.002.099	20,30,72	12.1018.001.099	98	15.3932.870H	43	19.3920.011.099	44	51.1009.022.099	94
08.1048.003.099	20,21,30,31,70,72,73	12.1018.002.099	98	15.3946.670F	37	19.3930.311.099	44	51.1009.025.099	94
08.1048.004.099	20,30,70,72	12.1018.003.099	98	15.3951.114	62	19.3953.174.099	62	51.1009.027.099	94
08.1049.001.099	32,33	12.1018.005.099	98	15.3961.174H	57,59	19.5740.311.099	24	51.1009.045.001	94
08.1049.002.099	32,33	12.1018.007.099	98	15.4001.740H	78	19.5750.011.099	56	51.1009.047.001	95
08.1049.003.099	32	12.1018.009.001	98	15.4001.840H	78	19.5770.311.099	56	51.1009.049.099	95
08.1049.004.099	32	12.1018.010.001	98	15.5701.840H	24	19.5890.011.099	65,69,87	51.1009.081.099	95
08.2770.001.000	52	12.1020.003.099	47,78	15.5711.870H	54	19.5890.012.099	65,69,87	51.1009.097.099	94
08.2910.001.002	52,101	12.1024.009.099	46	15.5750.840H	26	19.5891.011.099	65,87	51.1009.113.099	94
08.3200.233H	51,52,98,101,102	12.1024.010.099	46	15.5770.870H	56	19.5891.012.099	65,87	51.1009.121.099	94
08.3950.001.099	52,101	12.1024.011.099	46	15.5791.470H	39,42,57,59	20.1000.611.199	29,75,82	51.1009.122.099	94
08.5380.004.000	84	12.1024.012.099	46	15.5791.570.099	39,42,44	20.1000.612.199	29,75,82	51.1009.149.099	94
08.5752.012	51	12.1027.001.099	26	15.5801.840H	45	20.1000.613.199	29,75,82	51.1009.242.099	94
08.5752.024.099	28,45,46,51,52,74,81	12.1027.002.099	26	15.5811.871H	45	20.1000.614.199	29,75,82	51.1010.010.001	93
08.5890.300.099	65,87	12.1027.005.099	26	15.5811.872H	45	20.1016.004.000	104	51.1036.007.099	97
08.5890.301.099	65,87	12.1027.006.099	26	15.5891.611H	65,87	20.1042.002.099	53	51.1036.008.099	97
08.5892.001.099	65,87	12.1027.015.099	26	15.5891.612H	65,87	20.1042.003.099	53	51.1036.009.099	97
08.5892.002.099	65,69,87	12.1027.016.099	26	15.5891.721.099	65,69,87	20.2480.210H	103	51.1036.010.099	97
08.5892.003.099	65,69,87	12.1027.103.099	26	15.5891.722.099	65,69,87	20.2480.211H	103	51.1036.017.099	96
08.5892.004.099	65,87	12.1027.104.099	26	15.5891.741H	65,87	20.2480.213	99,103	51.1036.018.099	96
08.5892.105.099	65,69,87	12.1027.107.099	26	15.5891.742H	65,87	20.2480.216H	50,62,99,103	51.1036.021.099	97
09.1000.200.099	83	12.1027.108.099	26	15.6000.001.099	60	20.2480.217H	50,62,99,103	51.1036.022.099	97
09.1000.400.199	29,75,82	12.1027.203.099	26	15.6000.002.099	60	20.2480.223	103	51.1036.023.099	97
09.1041.002.099	53	12.1027.204.099	26	15.6000.003.099	60	20.2700.200H	50,99	51.1036.024.099	97
09.1041.004.099	53	12.1027.207.099	26	15.6000.004.099	60	20.2710.111H	99	51.1036.025.099	97
09.2000.301H	36,37,90,95,102	12.1027.208.099	26	15.9060.870H	22	20.2710.121	99	51.1036.026.099	97
09.2070.101H	36,38,54,80,102	12.1041.001.099	53	19.1000.101.099	83	20.2710.200H	50,99	51.1038.003.099	93
09.2770.001.000	52,101	12.1041.002.099	53	19.1000.102.099	83	20.2710.620	50,51,103	51.1038.004.099	93
09.2770.210	52	12.1041.003.099	53	19.1000.103.099	83	20.2710.650	51	51.1043.001.099	83
09.2770.211	52	12.1041.004.099	53	19.1000.104.099	83	20.3750.710.099	55	51.1043.002.099	83
09.2910.002.099	98,101	12.1041.005.099	53	19.1000.122.099	83	20.3750.720.099	55	51.1044.001.099	83
09.2910.003.099	52,101	12.1042.001.199	53	19.1000.001.199	29,75,82	20.3780.700H	58	51.1044.002.099	83
09.2910.004.099	101	12.1049.001.099	32,33	19.1000.602.199	29,75,82	20.3900.510H	28,74,81	51.1524.119H	92
09.2910.005.099	101	12.1049.002.099	32,33	19.1000.603.199	29,75,82	20.3900.520H	28,74,81	51.2491.121H	63
09.2910.007.000	101	12.3920.001.099	44	19.1008.041.099	34	20.5521.100H	24	51.2491.122H	63
09.3200.220	102	12.3920.002.099	44	19.1008.311.099	34	20.5700.410H	25	51.2493.121H	63
09.3200.320H	102	12.3930.001.099	44	19.1012.000.099	60	20.5700.420H	25	51.2493.127H	63
09.3200.420H	36,95,97,102	12.3930.002.099	44	19.1012.001.099	60	20.5750.710.099	56	51.2500.127H	80
09.3300.421	102	12.5590.009.099	27	19.1012.002.099	60	20.5750.720.099	56	51.2500.147H	80
09.3400.420	36,90,102	12.5700.001.099	25	19.1012.003.099	60	20.5800.410H	45	51.2510.127H	38
09.3900.003.000	74,75,81	12.5700.002.099	25	19.1013.011.099	49,89	20.5800.420H	45	51.2510.137H	38
09.5700.001.099	24	12.5700.003.099	25	19.1013.012.099	49,89	20.5800.610H	45	51.2510.147H	38
09.5700.002.099	24	12.5700.004.099	25	19.1013.813.099	49,89	20.5800.620H	45	51.2520.127H	80
09.5750.001.099	56	12.5740.002.099	24	19.1013.814.099	49,89	20.5800.710H	45	51.2520.147H	80
09.5750.002.099	56	13.1000.601.199	29,75,82	19.1018.311.099	98	20.5800.720H	45	51.2530.120H	54
09.5750.003.099	56	13.1000.602.199	29,75,82	19.1018.312.099	98	20.5800.750H	45	51.2530.140H	54
09.5750.220.099	34	13.1000.603.199	29,75,82	19.1019.013.099	79	20.7504.003.001	91	51.2540.120H	54
11.1036.011.099	97	13.1013.001.099	49,89	19.1019.014.099	79	20.7504.044.001	91	51.2540.130H	54
11.1036.012.099	97	13.1013.002.099	49,89	19.1019.313.099	79	40.1009.001.099	95	51.2540.140H	54
11.1036.013.099	97	13.1013.003.099	49,89	19.1019.314.099	79	40.1009.001.099	95	51.2890.117H	92
11.1036.014.099	97	13.1013.004.099	49,89	19.1020.213.099	47,78	40.1009.002.099	95	51.2890.147H	92
11.1039.001.099	67	13.1024.001.099	46	19.1020.613.099	47,78	40.1009.002.099	95	51.3000.002.001	91
11.1039.002.099	67	13.1024.002.099	46	19.1024.011.099	46	40.1009.003.099	95	51.3000.003.001	91
11.1039.011.099	67	13.1024.003.099	46	19.1024.012.099	46	40.1009.004.099	95	51.3200.147H	36
11.1039.012.099	67	13.1024.004.099	46	19.1024.311.099	46	40.1009.005.099	95	51.3400.147H	36
11.2770.102	52	13.1039.001.099	67	19.1024.312.099	46	40.1009.421.002	95	51.3410.127H	36
11.2770.202	52	13.1039.002.099	67	19.1027.011.099	26	40.1009.422.002	95	51.3410.140	36
11.2770.302	52	13.1043.001.000	83	19.1027.012.099	26	40.1009.433.099	95	51.3410.147H	36
11.2770.402	52	13.1044.001.000	83	19.1027.311.099	26	40.1009.434.099	95	51.3412.120H	36
11.2770.920	52	13.5800.100H	45	19.1027.312.099	26	40.1010.002.099	93	51.3490.110H	63
11.2780.910	51	13.5890.110.199	65,69,87	19.1033.001.199	74	40.1038.411.099	93	51.3490.120H	63
11.2780.920	51	13.5890.120.099	65,69,87	19.1033.002.199	74	40.1038.412.099	93	51.3635.201	92
11.2790.001.099	35	13.5890.210.199	65,69,87	19.1036.005.099	97	40.1038.751.099	93	51.3635.204	92
11.2790.002.099	35	13.5890.220.099	65,69,87	19.1036.006.099	97	40.1038.752.099	93	51.3635.206	92
11.2810.200H	62	14.5890.100.099	65,69,87	19.1036.007.099	97	40.1525.114H	92	51.3636.201	92
11.2910.001.000	101	14.5890.200.099	65,69,87	19.1036.008.099	97	40.2500.222H	80	51.3636.204	92
11.2910.002.000	101	15.2240.840H	84	19.1036.009.099	97	40.2500.422H	80	51.3636.206	92
11.2910.003.000	101	15.2711.114	50,99	19.1036.010.099	97	40.2510.222H	38	51.3640.127H	38
11.2910.006.000	101	15.2711.214H	63,85	19.1039.011.09					

MEKRA-catalogue articles MEKRA-Katalog-Artikel



51.3850.157	90	56.3812.148H	41	59.1008.017.099	34	59.1048.003.099	20,30,72	59.5590.014.099	27
51.3850.167H	90	56.3812.168H	41	59.1008.018.099	34	59.1048.004.099	20,30,72	59.5595.131H	24
51.3850.197H	90	56.3860.112H	40	59.1008.045H	34	59.1048.005.099	20,30,72	59.5595.132H	24
51.3850.227	90	56.3860.114H	40	59.1008.046H	34	59.1048.006.099	20,30,72	59.5595.235H	24
51.3850.247	90	56.3861.116H	40	59.1008.051H	34	59.1048.007.099	20,30,72	59.5595.236	24
51.3850.267	90	56.3862.116H	40	59.1008.052H	34	59.1048.008.099	20,30,72	59.5595.331H	24
51.3894.140H	91	56.3930.001.099	44	59.1008.057H	34	59.1048.009.099	20,30,72	59.5595.332	24
51.3920.001.099	44	56.3930.002.099	44	59.1008.058H	34	59.1048.010.099	20,30,72	59.5800.101H	45
51.3920.002.099	44	56.3930.003.099	44	59.1013.106.299	48,88	59.1048.011.099	20,30,72	59.5800.102H	45
51.3920.003.099	44	56.3930.004.099	44	59.1013.109.299	48,88	59.1048.012.099	21,31,70,73	59.5800.121H	45
51.3920.004.099	44	56.3931.323H	43	59.1013.117.299	48,88	59.1048.013.099	21,31,70,73	59.5800.122H	45
51.3920.005.099	44	56.3931.343H	43	59.1013.154.299	48,88	59.1048.014.099	21,31,70,73	59.5800.201H	45
51.3920.012.099	44	56.3932.323H	43	59.1013.159.299	48,88	59.1048.015.099	21,31,70,73	59.5800.202H	45
51.3920.013.099	44	56.3932.343H	43	59.1013.201.299	48,88	59.1048.016.099	21,31,70,73	59.5800.203H	45
51.3920.014.099	44	56.3960.148H	57,59	59.1013.202.299	48,88	59.1049.001.099	32,33	59.5800.221H	45
51.3921.222H	42	56.5730.120H	39	59.1013.212.299	48,88	59.1049.002.099	32	59.5800.222H	45
51.3921.223H	43	56.5730.140H	39	59.1013.216.299	48,88	59.1049.003.099	32	59.5800.223H	45
51.3921.224H	43	56.5790.002.099	44	59.1013.251.299	48,88	59.1049.004.099	32	59.5800.302H	45
51.3922.222H	42	56.5790.003.099	39,42	59.1013.253.299	48,88	59.1049.005.099	32	59.5800.322H	45
51.3922.223H	43	56.5790.004.099	39,42,57,59	59.1013.301.199	48,88	59.1049.006.099	32	59.5800.402H	45
51.3922.224H	43	56.9065.110	22	59.1013.309.199	48,88	59.1049.007.099	32	59.5800.422H	45
51.3923.223D	43	58.1000.611.199	29,75,82	59.1013.309.299	48,88	59.1049.008.099	32	61.1000.004.099	83
51.3923.224H	43	58.1000.612.199	29,75,82	59.1013.316.199	48,88	59.1049.009.099	32	61.1000.006.199	29,75,82
51.3924.223D	43	58.1000.613.199	29,75,82	59.1013.317.299	48,88	59.1049.010.099	32	61.1000.007.199	29,75,82
51.3924.224H	43	58.1000.614.199	29,75,82	59.1013.354.299	48,88	59.1049.011.099	33	61.1000.105.199	29,75,82
51.5524.930H	76,81,91	58.1000.621.199	29,75,82	59.1013.401.299	48,88	59.1049.012.099	33	61.1009.001.099	95
51.5720.120H	39	58.1000.622.199	29,75,82	59.1013.412.299	48,88	59.1049.013.099	33	61.1009.002.099	95
51.5720.140H	39	58.1000.623.199	29,75,82	59.1013.416.299	48,88	59.1049.014.099	33	61.1013.001.099	49,89
51.5721.160H	39	58.1000.624.199	29,75,82	59.1013.453.299	48,88	59.2652.110H	37	61.1013.002.099	49,89
51.5722.160H	39	58.1000.641.199	29,75,82	59.1013.501.199	48,88	59.2710.401H	99	61.1013.003.099	49,89
51.5750.001.099	56	58.1000.642.199	29,75,82	59.1013.509.299	48,88	59.2710.402H	99	61.1013.005.099	49,89
51.5750.002.099	56	58.1016.001.099	104	59.1013.601.299	48,88	59.2710.406	99	61.1013.153.099	49,89
51.5750.003.099	56	58.1016.002.099	104	59.1013.612.299	48,88	59.2710.454	99	61.1013.166.099	49,89
51.5750.004.099	56	58.1016.003.099	104	59.1013.651.299	48,88	59.2712.111	50	61.1013.253.099	49,89
51.5770.001.099	56	58.1016.004.099	104	59.1018.001.099	98	59.2712.114	50	61.1013.266.099	49,89
51.5891.111.199	64,86	58.1016.005.099	104	59.1018.002.099	98	59.2762.101	50	61.1013.366.099	49,89
51.5891.112.199	64,86	58.1016.006.099	104	59.1018.003.099	98	59.2762.322	50	61.1013.466.099	49,89
51.5891.113.199	64,86	58.1017.005.099	96	59.1018.004.099	98	59.2762.422	50	61.1013.501.099	49,89
51.5891.114.199	64,86	58.1017.006.099	96	59.1018.007.099	98	59.2770.210.099	52	61.1013.651.099	49,89
51.5891.211.199	64,86	58.1017.011.099	96	59.1018.008.099	98	59.2770.211.099	52	61.1017.080.099	96
51.5891.212.199	64,86	58.1017.012.099	96	59.1024.001.099	46	59.2770.310.099	52	61.1017.081.099	96
51.5891.213.199	64,86	58.1017.013.099	96	59.1024.002.099	46	59.2771.210.099	52	61.1024.224.099	26
51.5891.214.199	64,86	58.1017.014.099	96	59.1024.005.099	46	59.2780.120.099	51	61.1029.224.099	26
51.5891.311.199	64,86	58.1017.015.099	96	59.1024.006.099	46	59.2780.140.001	51	61.1039.002.099	67
51.5891.312.199	64,86	58.1017.016.099	96	59.1024.009.099	46	59.2780.150.001	51	61.1042.005.099	53
51.5891.313.199	64,86	58.1038.003.099	93	59.1024.010.099	46	59.2780.170.001	51	61.1042.006.099	53
51.5891.314.199	64,86	58.1038.004.099	93	59.1024.013.099	46	59.2780.180.001	51	61.2530.110H	54
51.5891.411.199	86	58.1038.147.099	93	59.1024.014.099	46	59.2780.200.001	51	61.2703.110	105
51.5891.412.199	64,86	58.1038.247.099	93	59.1024.017.099	46	59.2811.120	51	61.2703.120	105
51.5891.413.199	64,86	58.2704.044	105	59.1024.019.099	46	59.2810.111H	62	61.2708.842H	105
51.5891.414.199	64,86	58.2704.048	105	59.1024.022.099	46	59.2810.113H	62	61.2770.210	52
51.5892.111.199	64,86	58.2704.051H	105	59.1024.023.099	46	59.2910.001.001	100	61.2770.211	52
51.5892.112.199	64,86	58.2704.070	105	59.1024.025.099	46	59.2910.002.001	100	61.2770.900.099	52
51.5892.113.199	64,86	58.2704.086	105	59.1024.026.099	46	59.2910.003.001	100	61.2770.901.099	52
51.5892.211.199	64,86	58.2704.088	105	59.1024.027.099	46	59.2910.004.001	100	61.2772.100	52
51.5892.212.199	64,86	58.2704.093	105	59.1024.028.099	46	59.2910.005.001	100	61.2772.211.099	52
51.5892.213.199	64,86	58.2705.001H	105	59.1024.029.099	46	59.2910.006.001	100	61.2910.012.002	101
51.5892.311.199	64,86	58.2705.003	105	59.1024.030.099	46	59.2910.007.001	100	61.2910.021.001	101
51.5892.312.199	64,86	58.3752.100	55	59.1025.001.099	25,76,84	59.2910.008.001	100	61.2910.022.001	101
51.5892.313.199	64,86	58.3752.200	55	59.1025.002.099	25,76,84	59.2910.009.001	100	61.2910.003.001	101
51.5892.411.199	64,86	58.3783.200H	58	59.1027.001.099	26	59.2910.010.001	100	61.2910.004.001	101
51.5892.413.199	64,86	58.3783.300H	58	59.1027.002.099	26	59.2910.013.001	100	61.2910.005.001	101
51.5893.111.199	64,86	58.3900.133H	28,74,81	59.1027.003.099	26	59.2910.014.001	100	61.2910.006.001	101
51.5893.112.199	64,86	58.3900.143H	28,74,81	59.1027.004.099	26	59.2910.015.001	100	61.2910.011.002	101
51.5893.113.199	64,86	58.3900.233H	28,74,81	59.1039.101.099	66	59.2910.016.001	100	61.2910.012.002	101
51.5893.211.199	64,86	58.3900.243H	28,74,81	59.1039.105.099	66	59.2910.017.001	100	61.2910.021.001	101
51.5893.212.199	64,86	58.3900.333H	28,74,81	59.1039.125.099	66	59.2910.018.001	100	61.2910.022.001	101
51.5893.213.199	64,86	58.3900.433H	28,74,81	59.1039.151.099	66	59.2910.019.001	100	61.3000.003.010	91
51.5894.112.199	64,86	58.5700.001.099	25	59.1039.155.099	66	59.2910.020.001	100	61.3000.004.010	91
51.5894.212.199	64,86	58.5700.003.099	25	59.1039.158.099	66	59.3491.110H	63	61.3480.149H	23,76
51.5894.310.199	64,86	58.5700.004.099	25	59.1039.175.099	66	59.3491.120H	63	61.3482.149H	23,76
51.5894.410.199	64,86	58.5701.104.099	25	59.1039.201.099	66	59.3492.110H	63	61.3730.324H	22
51.5895.312.199	64,86	58.5710.001.099	25	59.1039.205.099	66	59.3492.120H	63	61.3730.326H	22
51.5895.412.199	64,86	58.5713.114.099	25	59.1039.225.099	66	59.3601.128H	80	61.3752.147H	55,62
51.7504.044.001	91	58.5750.005.199	56	59.1039.251.099	66	59.3601.178H	80	61.3752.167H	55,62
55.1008.002.099	35	58.5750.012.199	56	59.1039.255.099	66	59.3601.188H	80	61.3770.147H	55,58
55.1008.003.099	35	58.5752.100H	56	59.1039.258.099	66	59.3602.128H	80	61.3772.147H	55,58
55.1008.004.099	35	58.5752.200H	56	59.1039.275.099	66	59.3652.128H	37	61.3773.147H	55,58,62
55.3000.005.001	91	58.5800.101H	45	59.1039.501.099	68	59.3652.148H	37	61.3780.100H	58
56.1004.001.099	57,59,60	58.5800.102H	45	59.1039.551.099	68	59.3652.168H	37	61.3782.147H	58
56.1008.002.099	34	58.5800.201H	45	59.1039.575.099	68	59.3891.140H	91	61.3782.167H	58
56.1008.003.099	34	58.5800.202H	45	59.1039.601.099	68	59.3964.210H	57	61.3783.147H	58
56.1008.004.099	34	59.1000.611.199	29,75,82	59.1039.651.099	68	59.3965.210H	59	61.3783.167H	58
56.1020.015.099	47	59.1000.612.199	29,75,82	59.1039.675.099	68	59.3980.011H	62	61.3860.100	22



61.5700.310.099	24
61.5710.210H	24
61.5710.310.099	24
61.5721.004.099	39,84
61.5721.005.099	84
61.5721.006.099	84
61.5731.001.099	84
61.5740.001.099	24
61.5750.100H	56
61.9065.114H	22

OE		
Agco		
F743810150020	40.1009.421.002	95
F743810150030	40.1009.422.002	95
Adria Mobil		
9090 83003 00	20.2710.650	51
9095 83001 00	59.2760.005.001	--
9095 83001 00 A	59.2761.302	--
9095 83002 00	59.2760.006.001	--
9095 83010 00	59.1018.001.099	98
9095 83011 00	59.1018.002.099	98
9095 83012 00	12.1018.001.099	98
9095 83013 00	12.1018.002.099	98
9095 83014 00	12.1018.007.099	98
9095 83015 00	12.1018.009.001	98
9095 83016 00	12.1018.010.001	98
9095 83017 00	09.2910.005.099	98,101
9095 83018 00	09.2910.002.099	98,101
9095 83021 00	59.1018.025.001	--
RD 322 077 0	11.3730.210H	22,50,92,99
RD 322 244 0	19.1018.311.099	98
Bürstner		
202204008	11.3730.210H	22,50,92,99
2193829	12.1018.001.099	98
2193831	12.1018.002.099	98
2193831 MIT ANT	12.1018.012.001	--
2193839	12.1018.009.001	98
2193840	12.1018.010.001	98
2193841	12.1018.007.099	98
2218516	09.2910.002.099	98,101
2218519	09.2910.005.099	98,101
2247710	59.1018.021.001	--
2247727	59.1018.022.001	--
2247751	59.1018.023.001	--
2276379	59.1018.007.099	98
2304574	12.1018.005.099	98
2613741	59.1018.025.001	--
Z60000	20.2710.650	51
Z98889	51.3200.147H	36
68152322	59.2782.120	--
70025517	59.2910.003.001	100
70026237	59.2910.500.001	--
70026787	59.2781.120	51
70026788	20.2710.630	--
70026789	59.2910.017.001	100
70026790	61.2910.005.001	101
70026792	09.2910.002.099	98,101
70027178	61.2910.006.001	101
70027665	51.2540.140H	54
70028068	61.2530.110H	54
70029007	59.2770.210.099	52
70029251	15.2780.840	51,53,101
70029917	19.2910.001.099	53,101
70029941	15.2780.840	51,53,101
70029942	15.2780.870	51
70030418	59.2780.110	--
70030686	11.2910.007.000	101
70030687	11.2910.006.000	101
70030688	20.2780.631	--
70030875	19.2910.002.099	53,101
70030923	59.2780.120.099	51
70031268	11.2910.002.000	101
70031577	11.2910.001.000	101
70031996	11.2910.008.000	101
70032095	11.2910.003.000	101
70032122	61.2910.011.002	101
70032360	59.2910.014.001	100
70032377	59.2910.013.001	100
70033394	59.2910.009.001	100
70034438	61.2910.012.002	101
70034479	19.2910.001.099	53,101
70034480	19.2910.002.099	53,101
70034551	59.2780.160.001	--
70036218	61.2910.010.002	--
70036219	11.2910.011.002	101
70036220	61.2910.009.002	--
70036705	15.3802.840H	92
70037106	20.2710.620	50,51,103
70037291	11.2910.012.002	101
Carthago		
118016	20.2710.121	99
118017	20.2710.630	--
118023	20.2710.111H	99
118029	20.2710.200H	50,99
120565	56.3491.110H	63,85
120666	56.3492.110H	63,85
201619	12.1018.001.099	98
201620	12.1018.002.099	98
201621	12.1018.007.099	98
201622	12.1018.007.099	98
201623	12.1018.008.000	--
201624	12.1018.008.000	--
201931	09.2910.004.099	101
201932	15.2780.841F	51,98,101
201933	19.1018.311.099	98
201934	19.1018.312.099	98
203722	59.2910.019.001	100
203723	59.2910.020.001	100
207192	59.1018.007.099	98
207193	59.1018.008.099	98

OE		
207194	12.1018.005.099	98
207195	12.1018.009.001	98
207196	12.1018.010.001	98
107977	51.1009.017.099	94
110485	51.1009.246.001	--
112137	51.2510.127H	38
372807603	511.009.025.099	--
3728076-03	51.1009.025.099	94
Case New Holland (CNH)		
00437650	51.3850.227	90
47922739	51.1036.009.099	97
47922741	51.1036.010.099	97
47922743	51.1036.007.099	97
47922744	51.1036.008.099	97
48025196	19.1036.005.099	97
48025209	19.1036.006.099	97
236-5334	09.2500.300	--
290-5544 / 319-6789	51.3635.201	92
294-1991 / 316-6791	51.3635.204	92
294-1992	51.3636.204	92
308-3844	15.3731.470H	22,50,92,99
319-6787	11.3730.210H	22,50,92,99
319-6788	51.3636.201	92
319-6790	51.3636.204	92
372-8075	51.1009.017.099	94
372-8076	51.1009.246.001	--
415-3114	56.2660.147H	37
436-2886	51.1009.027.099	94
436-2887	51.1009.242.099	94
436-2890	20.1016.004.000	104
438-6751	09.3200.340	--
443-2540	51.1009.248.001	--
443-2541	51.1009.243.001	--
443-2541	51.1009.244.001	--
508-0795 ALT	51.1009.009.099	95
526-5057	51.1009.001.099	95
Caterpillar		
290-5544	51.3635.201	92
290-5545	51.3636.201	92
294-1991	51.3635.204	92
294-1992	51.3636.204	92
316-6791	51.3635.204	92
319-6788	51.3636.201	92
319-6789	51.3635.201	92
319-6790	51.3636.204	92
372-8075	51.1009.017.099	94
372-8076	51.1009.246.099	94
436-2886	51.1009.027.099	94
436-2887	51.1009.242.099	94
526-5057	51.1009.001.099	95
CITROEN		
1611711480	59.1048.007.099	20
1611711880	59.1048.006.099	20
1613689280	59.1048.001.099	20
1613689480	59.1048.004.099	20
1613691980	59.1048.001.099	20
1613692780	59.1048.003.099	20
1613692780	59.1048.005.099	20
1613693180	59.1048.002.099	20
1613693380	59.1048.003.099	20
1635187780	59.1048.001.099	20
1635193380	59.1048.003.099	20
1635683380	59.1048.006.099	20
1635683380	59.1048.006.099	20
1635685280	59.1048.003.099	20
1635685280	59.1048.005.099	20
1635685380	59.1048.002.099	20
1635685780	59.1048.004.099	20
1650901780	59.1048.007.099	20
1660711580	59.1048.011.099	20
1666450580	19.1048.005.099	20
1666450580	19.1048.005.099	21
1666450680	59.1048.010.099	20
1666450680	19.1048.005.099	20
1666450680	19.1048.005.099	21
1685327280	59.1048.001.099	20
1685327480	59.1048.009.099	20
1685327680	59.1048.011.099	20
1685328180	59.1048.004.099	20
1685329880	59.1048.010.099	20
1685330080	59.1048.003.099	20
1685332280	59.1048.007.099	20
1688409580	08.1048.003.099	20
1688409580	08.1048.003.099	21
1688409680	08.1048.004.099	20
6325H3	08.1048.001.099	20
6325H4	08.1048.002.099	20
735690575	59.1048.007.099	20
735706684	19.1048.006.099	20
735706684	19.1048.006.099	21
735706880	19.1048.006.099	20
735706880	19.1048.006.099	21
735706881	19.1048.006.099	20
735706881	19.1048.006.099	21
735706882	19.1048.006.099	20
735706882	19.1048.006.099	21
735706885	19.1048.006.099	20
735706885	19.1048.006.099	21

Cross-reference-table Vergleichsliste nach OE-Nummern

OE

Table with 3 columns: OE number, internal code, and quantity. Includes OE numbers like 73577338, 735773346, 765706886, etc.

Claas

Table with 3 columns: OE number, internal code, and quantity. Includes OE numbers like 11578380, 11578530, 11578540, etc.

Concorde

Table with 3 columns: OE number, internal code, and quantity. Includes OE numbers like 248268, 248269, 28421, etc.

OE

Table with 3 columns: OE number, internal code, and quantity. Includes OE numbers like 284262, 284263, 284264, etc.

DAF

Table with 3 columns: OE number, internal code, and quantity. Includes OE numbers like 1055967, 1401046, 1404868, etc.

OE

Table with 3 columns: OE number, internal code, and quantity. Includes OE numbers like 1736923, 20.3900.520H, 20.3900.510H, etc.

Vergleichsliste nach OE-Nummern Cross-reference-table

OE		
2430047	61.1000.006.199	29
2430048	61.1000.007.199	29
2430049	13.1000.601.199	29
2430050	13.1000.602.199	29
2430051	13.1000.603.199	29
2430052	19.1000.601.199	29
2430053	19.1000.602.199	29
2430054	19.1000.603.199	29
2430055	20.1000.611.199	29
2430056	20.1000.612.199	29
2430057	20.1000.613.199	29
2430058	20.1000.614.199	29
2436404	58.1000.611.199	29
2436405	58.1000.612.199	29
2436406	58.1000.613.199	29
2436407	58.1000.614.199	29
2436408	58.1000.621.199	29
2436409	58.1000.622.199	29
2436410	58.1000.623.199	29
2436411	58.1000.624.199	29
2436412	58.1000.641.199	29
2436413	58.1000.642.199	29
1404849 / 1796325	40.3485.403H	23,76
FIAT		
1660711580	59.1048.011.099	30
1685327680	59.1048.011.099	30
1685329780	59.1048.008.099	30
6000626717	08.1048.003.099	30
6000626717	08.1048.004.099	20
6000626717	08.1048.003.099	31
6000626718	08.1048.003.099	30
6000626718	08.1048.004.099	20
6000626718	08.1048.003.099	31
6000632355	19.1048.005.099	30
6000632355	19.1048.005.099	31
6000632356	19.1048.006.099	31
6000632356	19.1048.006.099	31
6000633330	08.1048.004.099	20
6000633331	08.1048.003.099	30
6000633331	08.1048.003.099	31
71748246	19.1048.001.099	30
71748246	19.1048.001.099	31
71748247	19.1048.002.099	30
71748247	19.1048.002.099	31
71748250	19.1048.003.099	30
71748250	19.1048.003.099	31
71748251	19.1048.004.099	30
71748251	19.1048.004.099	31
71748254	08.1048.001.099	30
71748255	08.1048.002.099	30
7177866	59.1048.006.099	30
71778662	59.1048.007.099	30
71778713	59.1048.005.099	30
735424425	59.1048.003.099	30
73542443	59.1048.005.099	30
735424433	59.1048.003.099	30
735440388	59.1048.001.099	30
735440390	59.1048.004.099	30
735440419	59.1048.003.099	30
73544042	59.1048.005.099	30
735440423	59.1048.002.099	30
735440425	59.1048.003.099	30
735480889	59.1048.004.099	30
735480916	59.1048.001.099	30
735480936	59.1048.003.099	30
735480940	59.1048.002.099	30
735480942	59.1048.005.099	30
735517043	59.1048.004.099	30
735517068	59.1048.001.099	30
735517075	59.1048.003.099	30
735517079	59.1048.002.099	30
735517081	59.1048.005.099	30
735588248	59.1048.007.099	30
735588252	59.1048.006.099	30
735620711	59.1048.004.099	30
735620753	59.1048.005.099	30
735661835	59.1048.007.099	30
735661846	59.1048.004.099	30
735661853	59.1048.004.099	30
735661853	59.1048.006.099	30
735661887	59.1048.005.099	30
73566846	59.1048.004.099	30
735706880	59.1048.009.099	30
735706884	59.1048.011.099	30
735706891	59.1048.008.099	30
735706895	59.1048.010.099	30
735773338	59.1048.007.099	30
735773348	59.1048.009.099	30
735773357	59.1048.011.099	30
735773372	59.1048.004.099	30
735773372	59.1048.006.099	30
735773387	59.1048.008.099	30
735773396	59.1048.010.099	30
735773405	59.1048.005.099	30
735782722	59.1048.013.099	31
735782723	59.1048.014.099	31
735782741	59.1048.016.099	31
735782747	59.1048.012.099	31
735782763	59.1048.015.099	31

OE		
8154LR	59.1048.001.099	30
FORD		
191114	59.1049.014.099	33
1823808	12.1049.002.099	32,33
1823809	12.1049.001.099	32,33
1823985	19.1049.004.099	32,33
1823986	19.1049.001.099	32,33
1823994	19.1049.003.099	32,33
1823995	19.1049.002.099	32,33
1855102	19.1049.006.099	32,33
1855103	19.1049.005.099	32,33
1911158	59.1049.013.099	33
2043755	08.1049.002.099	32,33
2085655	08.1049.001.099	32,33
2085657	08.1049.004.099	32
2208678	08.1049.003.099	32
2365898	59.1049.006.099	32
2365901	59.1049.008.099	32
2365911	59.1049.010.099	32
2365917	59.1049.004.099	32
2365929	59.1049.002.099	32
2365947	59.1049.005.099	32
2365950	59.1049.007.099	32
2366799	59.1049.009.099	32
2366803	59.1049.003.099	32
2366812	59.1049.001.099	32
BK31-17682-NA5JA	59.1049.014.099	33
BK31-17682-JJ5J6A	59.1049.012.099	33
BK31-17683-JJ5J6A	59.1049.011.099	33
BK31-17683-NA5JA	59.1049.013.099	33
KK3117682LB5JA	59.1049.002.099	32
KK3117683LB5JA	59.1049.001.099	32
Eura Mobil		
200070726	59.1018.001.099	98
200070727	59.1018.002.099	98
200070749	09.2910.005.099	98,101
200070751	09.2910.002.099	98,101
200070813	12.1018.007.099	98
200070814	12.1018.009.001	98
200070817	12.1018.001.099	98
200070820	12.1018.002.099	98
200070822	12.1018.010.001	98
200083487	59.2760.005.001	--
200083496	59.2760.006.001	--
VI10-01-008B	11.3730.210H	22,50,92,99
VI10-02-001	51.3400.147H	36
VI10-02-004	09.3200.340	--
Fendt/Valtra		
F297810150010	40.2890.222H	90,92
F304810150030	40.1009.002.000	95
F743810150010	40.1009.001.000	95
G297810150030	51.3850.127H	90
G304810150020	51.1009.017.099	94
G816810150030	51.2890.117H	92
ACV0148490	51.1009.097.099	94
ACV0759270	40.1009.004.099	95
ACV0759280	40.1009.002.099	95
ACV0805960	51.1009.017.099	94
Heuliez		
50344917	15.2780.840	51,53
HINO		
879020002	51.3300.147H	--
879020008C	11.9060.100H	22
879020009	59.3604.178H	--
879020009G	40.3605.203H	80
879020010	59.5524.820	--
879020011	51.5524.930H	76,81,91
879020017	51.3636.206	92
87902003	56.9065.110	22
87902007C	11.3730.210H	22,50,92,99
87902007G	15.3802.840H	92
87902008	61.9065.114H	22
87902008G	15.9060.870H	22
87930-0008A	59.2652.110H	37
Hymmer		
0850034	40.3640.322H	38
1015718	55.2020.177H	--
1287034	59.2761.302	--
1289691	20.2480.222	--
1299452	20.2700.200H	50,99
1316712	58.2704.065	--
2668945	11.2780.920	51
2673925	20.2710.620	50,51,103
2674190	51.3200.137H	--
2698004	40.3640.322H	38
2698008	09.3200.360	--
2698087	56.1471.117	--
2725823	11.3730.210H	22,50,92,99
2726750	59.2761.112	--
2771210	40.2500.322	--
2943025	20.2760.140	--
2943027	20.2760.150	--
38.305	56.1471.117	--
383183	51.2510.127H	38
VI10-02-005	40.3640.322H	38
Irisbus		
42545989	15.2712.114	50,99

OE		
42545990	11.3730.210H	22,50,92,99
42545988	15.2711.114	50,99
5006232165	58.2704.088	105
5006232166	58.2704.089	--
5006232482	51.3732.326	50,99
71101611	59.2710.411	--
71101611/612 SO	20.2710.200H	50,99
71101612	59.2710.412	--
71701878	09.3200.220	102
Iveco		
42309921	51.1523.111H	--
42545983	59.2710.412	--
42545985	20.2480.217H	50,62,99,103
42556227	11.3730.210H	22,50,92,99
42556228	15.3731.470H	22,50,99
500086749	192.790.012.099	35
500086750	192.790.011.099	35
500086753	192.790.031.099	35
500086754	192.790.032.099	35
5001851891	11.2810.200H	62
50104404852	59.2810.113H	62
5010411090	59.2810.111H	62
503449902	11.2770.920	52
503449909	15.2771.840	52
503651179	11.2770.920	52
504150526	59.1008.005.099	34
504150527	59.1008.006.099	34
504150538	59.1008.011.099	34
504150539	59.1008.012.099	34
504150551	59.1008.017.099	34
504150552	59.1008.018.099	34
504168236	56.1008.002.099	34
504168237	56.1008.003.099	34
504168238	56.1008.004.099	34
504168244	11.1008.001.099	34
504197878	19.1008.041.099	34
504197879	19.1008.311.099	34
504224428	55.1008.002.099	35
504369910	59.1008.005.099	34
504369916	59.1008.006.099	34
504369979	59.1008.017.099	34
504369995	59.1008.018.099	34
504370048	59.1008.011.099	34
504370055	59.1008.012.099	34
5801334610	59.1008.006.099	34
5801334614	59.1008.005.099	34
5801336285	59.1008.011.099	34
5801336298	59.1008.012.099	34
5801341206	59.1008.017.099	34
5801341207	59.1008.018.099	34
5801404796	59.2770.211.099	52
5801404799	59.2762.101	50
5802498968	112.790.001.099	35
5802498969	112.790.002.099	35
John Deere		
AKK34593	51.1009.113.099	95
AL158964	51.3850.127H	90
AL203151	15.5701.840H	24
AL225722	61.1017.080.099	96
AL225823	19.1036.007.099	97
AL225824	19.1036.008.099	97
AL232743	51.1036.017.099	96
AL232744	51.1036.018.099	96
AL237885	61.1017.081.099	96
AZ100260	56.2650.121H	37
AZ100261	11.1523.010	--
AZ104094	51.3636.205	--
AZ104180	51.3635.205	--
AZ65395	40.3300.318	--
R566924	11.1036.011.099	97
Kässbohrer		
8.688.000.244.0	40.2520.422H	80
8.688.000.256.0	09.3200.320H	102
8.688.032.13.0	10.6321.100	36,37
8.688.100.253.0	40.2890.422H	90,92
8.688.105.262.0	09.3200.340	--
8.688.105.264.0	11.3730.210H	22,50,92,99
8.688.117.000.0	51.1009.250.001	--
8.688.120.000.0</		

Cross-reference-table Vergleichsliste nach OE-Nummern

OE		
1000396281	51.1009.097.099	94
Liebherr		
10218823	55.3000.108H	--
10285254	55.2020.177H	--
10287949	51.3636.206	92
10287953	51.3635.206	92
10300676	56.2600.127H	36
10303351	51.3640.137H	38
10334227	11.3730.210H	22,50,92,99
10342167	09.2070.101H	36,38,54,80,92,102
10470601	15.3802.840H	92
10472808	58.2600.010H	37
10472809	56.2660.147H	--
10675116	40.2635.204F	--
10877369 / 5707 57877	51.2520.127H	80
11008727	51.3640.128.001	--
11066581	58.2704.075.001	--
11068341	51.1009.017.099	94
11181691	51.1009.049.001	--
11182172	09.2070.101H	36,38,54,80,92,102
1118692	09.2000.301H	36,37,90,95,102
11657850	61.3480.149H	23,76
11657851	58.1016.001.099	104
11657852	58.1016.002.099	104
11657853	58.1016.005.099	104
11657854	58.1016.006.099	104
11657855	20.1016.004.000	104
11830241	11.1200.502.099	--
11830530	59.1005.004.001	--
11931048	20.2710.630	--
12218370	59.1005.004.001	--
12230063	40.1009.001.000	95
12230064	40.1009.003.099	--
12254474	09.3200.320H	102
12269787	58.1016.004.099	104
571070008	09.2070.101H	36,38,54,80,92,102
571229808	40.2520.422H	80
571572108	09.3200.340	--
571572208	09.3200.220	102
571757008	08.3492.324.099	--
591055977	59.2640.110H	--
591056608	51.2520.147H	80
591059377	56.2660.127H	37
591060808	56.2640.127H	--
591061008	56.2661.147	--
591069208	09.3200.440	--
591070908	56.2630.127	--
591077608	58.2704.042	--
591080008	58.2486.507	--
7004956	51.1524.119H	92
7005028	51.3640.127	--
7017444	56.2660.127H	37
7021442	51.3640.147H	38
7022092	51.2461.117H	--
7616670	51.1523.121H	--
7619627	55.2021.177	--
7621216	20.2480.210H	103
7621717	51.2530.128H	--
Lindner		
3006104	51.3495.112H	--
3006232	56.3492.110H	63,85
3006233	56.3491.110H	63,85
3009960	51.1009.043.001	--
3009961	58.1017.011.099	96
3009999	58.1017.012.099	96
3010115	51.1009.001.099	95
3010188	51.1009.081.099	95
3010662	51.1009.017.099	94
3010850	51.1009.021.099	94
3010851	51.1009.022.099	94
3010852	51.1009.121.099	94
3010853	51.1009.122.099	94
3022116	40.1009.001.000	95
3205677	40.1009.004.099	95
3205678	40.1009.002.099	95
3207388	40.1009.002.000	95
3207415	11.1009.004.000	--
MAN		
11075175	59.2762.101	50
16100772027	09.3400.420	36,90,102
33.25203-6001	08.2910.001.002	52,101
33.25404-6190	09.2770.211	--
33.28104-6355	09.1041.004.099	53
33.63700-6003	59.1042.005.099	53
33.63700-6004	59.1042.001.099	53
33.63730-6003	51.3635.206	92
33.63731-6002	58.2705.002	--
336373060001	51.3850.267	90
36.25404-6033	09.1041.002.099	53
36.63700-6017	59.1042.001.099	53
36.63700-6018	59.1041.001.099	53
36.63700-6019	59.1042.003.099	53
36.63700-6020	59.1042.004.099	--
36.63700-6022	59.1042.002.099	--
36.63730-6013	56.1523.117H	--
36.63730-6024	59.2910.500.001	--
36.63731-6000	20.2710.630	50,51,103
36.63731-6001	20.2710.620	--
36.63731-6012	20.1042.002.099	53

OE		
36.63731-6013	20.1042.003.099	53
36.63732-0000	11.2770.102	52
36.63732-0001	11.2770.302	52
36.63732-0002	11.2770.202	52
36.63732-0003	11.2770.402	52
36.63732-0004	11.2770.620	--
36.63732-0006	11.2780.920	51
36.63732-0024	61.2910.009.002	--
36.63732-0033	12.1041.004.099	53
36.63732-0034	12.1041.003.099	53
36.63732-0036	12.1041.005.099	53
36.63732-0037	12.1041.001.099	53
36.63732-0040	12.1042.001.099	53
36.63732-0041	12.1042.002.099	--
36.63732-0044	11.2910.017.000	--
36.63732-6000	61.2770.900.099	52
36.63733-0009	19.2910.002.099	53,101
36.63733-0010	19.2910.001.099	53
36.63733-0011	15.2780.840	53
36.63733-0012	19.2910.002.099	53
36.92611-0002	11.2770.040	--
65.25320-0000	08.1013.012.199	49
65.25320-0001	08.1013.013.199	49
65.25320-0002	08.1013.712.199	49
65.25320-0003	08.1013.713.199	49
65.25320-6001	08.1013.012.199	49
65.25320-6002	08.1013.013.199	49
65.25320-6003	08.1013.712.199	49
65.25320-6004	08.1013.713.199	49
65.63731-6008	61.1013.005.099	49
65.63731-6025	61.1013.501.099	49
65.63731-6026	61.1013.651.099	49
65.63731-6033	61.1013.166.099	49
65.63731-6034	61.1013.266.099	49
65.63731-6037	61.1013.366.099	49
65.63731-6038	61.1013.466.099	49
65.63731-6041	61.1013.166.099	49
65.63731-6042	61.1013.153.099	49
65.63731-6045	61.1013.266.099	49
65.63731-6046	61.1013.253.099	49
65.63731-6048	61.1013.366.099	49
65.63731-6051	61.1013.466.099	49
65.63731-6056	61.1013.651.099	49
65.63732-0000	13.1013.003.099	49
65.63732-0001	13.1013.004.099	49
65.63732-0002	13.1013.001.099	49
65.63732-0003	13.1013.002.099	49
65.63732-6000	61.1013.003.099	49
65.63732-6001	61.1013.002.099	49
65.63733-0006	19.1013.013.099	49
65.63733-0012	19.1013.012.099	49
65.63733-0013	19.1013.011.099	49
65.63733-0014	19.1013.013.099	49
65.63733-0015	19.1013.011.099	49
65.63733-0020	19.1013.813.099	49
65.63733-0021	19.1013.814.099	49
65.63733-0022	19.1013.011.099	49
65.63733-0023	19.1013.011.099	49
65.63733-0024	19.1013.012.099	49
65.63733-0026	19.1013.012.099	49
65.63734-0000	61.1013.001.099	49
65.63734-0002	08.1013.010.099	49
7C1857387FJ	59.1013.117.299	48
7C1857387FK	59.1013.109.299	48
7C1857387FM	59.1013.106.299	48
7C1857387GA	59.1013.117.299	48
7C1857387GB	59.1013.109.299	48
7C1857387GC	59.1013.159.299	48
7C1857387GD	59.1013.106.299	48
7C1857387GE	59.1013.154.299	48
7C1857388EC	59.1013.212.299	48
7C1857388EG	59.1013.216.299	48
7C1857388EH	59.1013.201.299	48
7C1857388EK	59.1013.202.299	48
7C1857388EM	59.1013.216.299	48
7C1857388EP	59.1013.201.299	48
7C1857388EQ	59.1013.251.299	48
7C1857388ES	59.1013.202.299	48
7C1857388ET	59.1013.253.299	48
7C1857388FC	59.1013.212.299	48
7C2857387CN	59.1013.317.299	48
7C2857387CP	59.1013.309.299	48
7C2857387DA	59.1013.317.299	48
7C2857387DC	59.1013.309.299	48
7C2857387DE	59.1013.354.299	48
7C2857388BT	59.1013.412.299	48
7C2857388CB	59.1013.416.299	48
7C2857388CC	59.1013.401.299	48
7C2857388CE	59.1013.416.299	48
7C2857388CF	59.1013.401.299	48
7C2857388CG	59.1013.453.299	48
7C2857388CJ	59.1013.412.299	48
7CB857387BC	59.1013.509.299	48
7CB857387BG	59.1013.509.299	48
7CB857388AL	59.1013.601.299	48
7CB857388AN	59.1013.612.299	48
7CB857388AR	59.1013.601.299	48
7CB857388AS	59.1013.651.299	48
7CB857388BB	59.1013.612.299	48

OE		
81.25404-6247	09.3200.310H	--
81.25406-6252	09.3200.360	--
81.25432-0149	09.2070.101H	36,38,54,80,92,102
81.25505-6247	08.2770.001.000	52
81.25525-0232	08.3200.233H	51,52,98,101,102
81.62410-0107	20.5800.710H	45
81.62410-0108	20.5800.720H	45
81.62410-0109	20.5800.750H	45
81.62730-6221	51.3410.147H	36
81.63730-6127/6167	51.2510.127H	38
81.63730-0032	40.3640.422H	36,38
81.63730-0058	08.3400.324	--
81.63730-0066	15.3731.070H	--
81.63730-0082	61.2770.110	--
81.63730-0083	61.2770.210	52
81.63730-6001	51.3640.147H	38
81.63730-6003	40.3640.422H	36,38
81.63730-6016	51.3400.147H	36
81.63730-6094	51.2460.218H	--
81.63730-6108	51.3640.127H	38
81.63730-6126	51.3640.127H	38
81.63730-6128	51.2510.147H	38
81.63730-6138	56.1562.110	--
81.63730-6147	51.3640.127H	38
81.63730-6148	51.3640.127H	38
81.63730-6149	51.3640.127H	38
81.63730-6151	51.3640.147H	38
81.63730-6193	51.3200.147H	36
81.63730-6194	51.3640.127H	38
81.63730-6202	40.3640.422H	36,38
81.63730-6206	56.2600.127H	36
81.63730-6220	51.3410.127H	36
81.63730-6221	51.3410.147H	36
81.63730-6222	56.2660.127H	37
81.63730-6223	56.2660.147H	37
81.63730-6224	56.2660.121H	37
81.63730-6233	51.3410.127H	36
81.63730-6234		

Cross-reference-table Vergleichsliste nach OE-Nummern

OE			OE			OE		
8111307	61.3780.100H	55,57,58,59,62	66560398	56.3492.110H	63,85	9068106516	51.5892.213.199	64,86
8111807	20.5750.710.099	56	2818107116	51.2530.120H	54	9068106593	51.5894.112.199	--
8111907	20.5750.720.099	56	3018102116	51.2530.140H	54	9068106616	51.5892.413.199	64,86
8111933	40.2540.222H	54	3148101316	51.2540.120H	54	9068106693	51.5894.212.199	--
8112007	61.5750.100H	56	3148101916	51.2540.130H	54	9068106716	51.5892.313.199	64,86
8112033	40.2530.222H	54	3148102016	51.2540.140H	54	9068106816	51.5893.113.199	64,86
8112133	40.2530.222H	54	3148102616	51.2530.140H	54	9068106916	51.5893.213.199	64,86
8113333	40.2530.222H	54	3578110471	11.3730.210H	22,50,92,99	9068107993	51.5895.412.199	--
8113533	40.2540.222H	54	3818102516	51.2530.120H	54	9068108093	51.5895.312.199	--
8114033	15.5891.722.099	65,69,87	3818102816	51.2530.140H	54	9108100300	59.1039.125.099	66
8114730	51.3209.197	--	3818107116	51.2530.120H	54	9108100400	59.1039.225.099	66
8115130	51.3490.282E	--	3818107216	51.2530.130H	--	9108100401	59.1039.525.099	--
8115330	51.3490.272E	--	3818107316	51.2530.140H	54	9108100500	59.1039.175.099	66
8115530	51.3490.182E	--	4068105216	51.1522.211H	--	9108100501	59.1039.625.099	--
8115630	51.3491.101E	--	4168100416	51.1523.111H	--	9108100600	59.1039.275.099	66
8115730	51.3491.102.099	--	6118100116	51.3490.110H	63	9108100601	59.1039.575.099	68
8116433	40.2530.222H	54	6228100116	59.3980.141	62	9108100701	59.1039.675.099	68
8117733	40.3200.422H	36	6288103016	59.3980.121	--	9108100801	59.1039.501.099	68
8118433	40.3680.222H	--	6288103116	59.3980.122	62	9108100901	59.1039.601.099	68
8119133	40.3665.118F	--	6288103316	59.3980.111	62	9108101001	59.1039.551.099	68
8130436	14.5890.100.099	65,69,87	6288103416	59.3980.112	--	9108101100	59.1039.104.099	--
8130536	14.5890.200.099	65,69,87	6288103616	59.3980.131	--	9108101101	59.1039.651.099	68
8201277	08.5892.105.099	65,69,87	6288103716	59.3980.132	62	9108101200	59.1039.204.099	--
8202713	09.5750.001.099	56	6298100416	59.3951.300	--	9108101300	59.1039.154.099	--
8202813	09.5750.220.099	56	6298110033	15.3951.174	--	9108101400	59.1039.254.099	--
8205198	10.6221.100	--	6298110133	15.3951.114	62	9108101601	59.1039.701.099	68
8210129	10.3681.400	--	6298110233	15.3952.174	--	9108101701	59.1039.801.099	68
8210829	40.2540.422H	64	6338100216	59.3980.142	62	9108101801	59.1039.751.099	68
8210929	10.6211.140	52	6418104216	51.3680.147H	--	9108101900	59.1039.105.099	66
8211229	10.3681.400	--	6418104416	51.3680.167H	--	9108101901	59.1039.851.099	68
18104414	58.3781.100H	--	6418106816	51.3680.147H	--	9108102000	59.1039.205.099	66
18104514	58.3781.200H	--	6638100816	51.2530.120H	54	9108102100	59.1039.155.099	66
18106016	15.2711.114	50,99	6718100095	20.2710.620	50,51,103	9108102200	59.1039.255.099	66
18106116	15.2712.114	50,99	6718100716	59.3980.011H	62	9108107001	59.1039.558.099	--
18107216	51.3731.326	50,99	6718100916	59.3980.021H	62	9108107101	59.1039.658.099	--
18109016	61.3783.147H	58	6718101316	59.3980.022H	62	9108108901	59.1039.101.099	66
18109116	61.3783.167H	58	6718101111	20.2480.210H	103	9108109001	59.1039.201.099	66
18109216	61.3773.147H	55,58,62	6738100816	51.2530.120H	54	9108109101	59.1039.151.099	66
18109714	58.5752.100H	56	6738103916	51.2540.120H	54	9108109201	59.1039.251.099	66
18109814	58.5752.200H	56	6738104016	51.2530.120H	54	9108109501	59.1039.158.099	66
18109914	58.5752.300H	56	6738104116	51.2540.140H	54	9108109601	59.1039.258.099	66
18110022	13.5890.120.099	65,69,87	6738104216	51.2530.140H	54	9108112400	19.1039.412.099	67
18110122	13.5890.220.099	65,69,87	8919978658	40.2540.422H	54	9108112500	19.1039.411.099	67
18110433	15.3491.372H	63,85	9018100116	51.3490.110H	63	9108112600	19.1039.012.099	67
18110533	15.3491.371H	63,85	9018100216	51.3490.120H	63	9108112700	19.1039.011.099	67
18110633	15.3491.071H	63,85	9018100916	51.3490.112H	--	9108112800	19.1039.812.099	67
18110733	15.3491.072H	63,85	9018101016	51.3490.122H	--	9108112900	19.1039.811.099	67
18111022	13.5890.110.199	65,69,87	9018101093	56.3491.110H	63,85	9108113600	19.1039.312.099	67
18111433	40.2660.404H	37	9018101193	56.3492.110H	63,85	9108113700	19.1039.311.099	67
18112033	15.3784.470H	58	9018102516	59.3491.110H	63	9108113800	11.1039.012.099	67
18112133	15.3774.410H	55,58	9018102616	59.3491.120H	63	9108113900	11.1039.011.099	67
18112233	15.3794.410H	--	9018103716	59.3492.110H	63	9108114000	13.1039.002.099	67
18113433	15.3752.470H	55,62	9018103816	59.3492.120H	63	9108114100	13.1039.001.099	67
18116033	15.3771.174H	55,58,62	9018105716	51.3490.112H	--	9108114400	11.1039.002.099	67
18116933	15.3961.174H	57,59	9018105816	59.3491.110H	63	9108114500	11.1039.001.099	67
18117333	15.3752.470H	55,62	9018106116	59.3492.110H	63	9108250400	61.1039.002.099	67
18118633	40.3680.222H	--	9018106416	51.3490.120H	63	9109064600	08.1039.002.099	67
18118733	40.2530.222H	54	9018106616	51.3490.122H	--	9109064700	08.1039.001.099	67
18119033	40.2540.222H	54	9018106716	59.3491.120H	63	9109065600	08.1039.011.099	67
18119933	15.5750.840H	56	9018107016	59.3492.120H	63	9408105516	59.3964.210H	57
18210029	10.6221.100	38,90,92	9068101893	51.5891.111.199	64,86	9418101016	59.3792.127H	--
18228920	08.5892.001.099	65,87	9068101993	51.5891.211.199	64,86	9418102116	59.3792.127H	--
18229020	08.5892.003.099	65,69,87	9068102093	51.5891.411.199	86	9418110007	20.3780.700H	58
18229220	08.5892.004.099	65,87	9068102293	51.5892.111.199	64,86	9438104716	59.3965.210H	59
18229320	08.5892.002.099	65,69,87	9068102393	51.5892.211.199	64,86	9578110033	40.3605.204F	80
18271104	09.2810.220	--	9068102493	51.5892.411.199	64,86	9738100314	58.3752.100	55
28100014	58.5752.400E	--	9068102593	51.5892.311.199	64,86	9738100414	58.3752.200	55
28100814	58.3783.300H	58	9068102693	51.5893.111.199	64,86	9738107316	59.3962.210H	--
28100816	56.5790.004.099	39,42,57,59	9068102793	51.5893.211.199	64,86	86880001840	51.3640.127	--
28100914	58.3783.200H	58	9068103093	51.5891.112.199	--	86880320130	10.6321.100	36,37
28104216	51.3770.001.002	--	9068103193	51.5891.212.199	--	86880410010	40.2500.222H	80
28106016	56.1004.001.099	57,59,60	9068103293	51.5891.412.199	--	86880410290	10.6121.100	36,38
28108514	58.5750.012.199	56	9068103393	51.5891.312.199	--	86880751690	08.2810.124	--
28109014	58.5750.013.199	--	9068103493	51.5892.112.199	--	86880902140	11.2810.200H	62
28109414	58.5750.005.199	56	9068103593	51.5892.212.199	--	86880902250	20.2810.310	--
28109614	58.5750.006.199	--	9068103693	51.5892.412.199	--	87480181000	51.2510.127H	38
28110033	15.5770.870H	56	9068103793	51.5892.312.199	--	89199311514	08.3200.500	--
28110333	15.3791.470H	--	9068103893	51.5893.112.199	--	89199718444	40.2540.422H	54
28110433	15.3780.840H	58	9068103993	51.5893.212.199	--			
28111533	15.5891.741H	65,87	9068104293	51.5891.114.199	--	Morelo		
28111633	15.5891.742H	65,87	9068104393	51.5891.214.199	--	205804	59.1018.007.099	98
28111933	15.5891.611H	65,87	9068104493	51.5891.414.199	--	205805	59.1018.008.099	98
28112033	15.5891.612H	65,87	9068104593	51.5891.314.199	--	205815	12.1018.001.099	98
28112233	15.5791.470H	39,42,57,59	9068104816	51.5891.111.199	64,86	205816	12.1018.002.099	98
28113333	19.1012.002.099	60	9068104916	51.5891.211.199	64,86	205820	12.1018.005.099	98
28113433	19.1012.003.099	60	9068105016	51.5891.411.199	86	205822	12.1018.009.001	98
28113733	19.1012.000.099	60	9068105116	51.5891.311.199	64,86	205824	12.1018.010.001	98
28113833	19.1012.001.099	60	9068105216	51.5892.111.199	64,86	205825	09.2910.005.099	98,101
28113933	15.5891.721.099	65,69,87	9068105316	51.5892.211.199	64,86	205826	09.2910.002.099	98,101
28114633	19.5750.011.099	56	9068105416	51.5892.411.199	64,86			
28114733	19.5770.311.099	56	9068105516	51.589				

Vergleichsliste nach OE-Nummern Cross-reference-table

OE		
8020384-00	59.2780.230	--
8020385	59.2780.130	--
8034580	15.2780.841F	51,98,101
8034581 / 21082	15.2780.871F	51
8042965 / 23144	09.2910.005.099	98,101
8042972	59.1018.007.099	98
8042978 / 22922	59.1018.008.099	98
8049172	19.1018.311.099	98
8049173	19.1018.312.099	98
8061674 / 28852	12.1018.001.099	98
8061675 / 28852	12.1018.005.099	98
8061676	12.1018.010.001	98
8061677 / 28852	12.1018.002.099	98
8061679	12.1018.009.001	98
PEUGEOT		
1611711480	59.1048.007.099	72
1611711880	59.1048.006.099	72
1613689280	59.1048.001.099	72
1613689480	59.1048.004.099	72
1613691980	59.1048.001.099	72
1613692780	59.1048.003.099	72
1613692780	59.1048.005.099	72
1613693180	59.1048.002.099	72
1613693380	59.1048.003.099	72
1635187780	59.1048.001.099	72
1635193380	59.1048.003.099	72
1635683380	59.1048.006.099	72
1635683380	59.1048.006.099	72
1635685280	59.1048.003.099	72
1635685280	59.1048.005.099	72
1635685380	59.1048.002.099	72
1635685780	59.1048.004.099	72
1650901780	59.1048.007.099	72
1660711580	59.1048.011.099	72
1666450580	19.1048.005.099	72
1666450580	19.1048.005.099	72
1666450680	59.1048.010.099	73
1666450680	19.1048.005.099	72
1666450680	19.1048.005.099	73
1685327280	59.1048.001.099	72
1685327480	59.1048.009.099	72
1685327680	59.1048.011.099	72
1685328180	59.1048.004.099	72
1685329880	59.1048.010.099	72
1685330080	59.1048.003.099	72
1685332280	59.1048.007.099	72
1688409580	08.1048.003.099	72
1688409580	08.1048.003.099	73
1688409680	08.1048.004.099	72
6325H3	08.1048.001.099	72
6325H4	08.1048.002.099	72
735690575	59.1048.007.099	72
735706684	19.1048.006.099	72
735706684	19.1048.006.099	73
735706880	19.1048.006.099	72
735706880	19.1048.006.099	73
735706881	19.1048.006.099	72
735706881	19.1048.006.099	73
735706882	19.1048.006.099	72
735706882	19.1048.006.099	73
735706885	19.1048.006.099	72
735706885	19.1048.006.099	73
735773338	59.1048.007.099	72
735773346	59.1048.007.099	72
765706886	19.1048.006.099	72
765706886	19.1048.006.099	73
8151LJ	19.1048.001.099	72
8151LJ	19.1048.001.099	73
8151LK	19.1048.002.099	72
8151LK	19.1048.002.099	73
8151LP	19.1048.003.099	72
8151LP	19.1048.003.099	73
8151LQ	19.1048.004.099	72
8151LQ	19.1048.004.099	73
8153NS	59.1048.004.099	72
8153PE	59.1048.006.099	72
8153PL	59.1048.005.099	72
8153PR	59.1048.003.099	72
8153W3	59.1048.004.099	72
8153X2	59.1048.006.099	72
8153X6	59.1048.005.099	72
8153Y0	59.1048.003.099	72
815428	59.1048.001.099	72
815430	59.1048.004.099	72
815439	59.1048.006.099	72
815459	59.1048.005.099	72
8154KV	59.1048.004.099	72
8154LR	59.1048.001.099	72
8154LZ	59.1048.003.099	72
8154LZ	59.1048.005.099	72
8154PH	59.1048.006.099	72
Plaxton		
039125C	55.3000.117	--
083895B	59.2710.454	99
105137C	59.5520.530H	90
158388C	59.2910.017.001	100
158388C-1	61.2910.010.002	--
158388C-2	19.2910.002.099	53,101
158396C	59.2910.018.001	100

OE		
158396C-1	61.2910.020.002	--
175202B-10	12.1018.003.099	98
175202B-11	09.2910.005.099	98,101
175202B-4	19.1018.314.000	--
175202B-6	12.1018.002.099	98
175202B-7	12.1018.001.099	98
175202B-8	12.1018.010.001	98
175202B-9	12.1018.009.001	98
198806C	59.2780.120.099	51
68152256	61.2910.001.001	101
76802907	09.2910.002.099	98,101
AA01976	59.2710.401H	99
AA01977	59.2710.406	99
AA01978	20.2710.200H	50,99
AA01980	20.2480.213	99,103
AA-01980	20.2480.213	99,103
AA-01982	20.2710.111H	99
AA-01983	20.2710.121	99
AP064924B	59.2704.122	--
AP064924B-3	20.2700.161	--
AP064924B-4	20.2480.211H	103
AP083895B-1	15.2712.113F	99
AP105367C-3	15.3802.840H	92
AP107424C-10	20.2480.217H	50,62,99,103
AP107424C-4	51.3636.206	92
AP119170C-10	11.2910.003.000	101
AP119170C100	59.2910.003.001	100
AP119170C-100	59.2910.003.001	100
AP119170C-11	11.2910.006.000	101
AP119170C-12	11.2910.008.000	101
AP119170C-13	11.2910.002.000	101
AP119170C-14	61.2910.011.002	101
AP119170C-15	11.2910.007.000	101
AP119170C-16	61.2910.012.002	101
AP119170C-17	11.2910.011.002	101
AP119170C-18	11.2910.012.002	101
AP119170C-2	59.2910.010.001	100
AP119170C-5	61.2910.009.002	--
AP119170C-6	61.2910.019.002	--
AP119170C-7	19.2910.001.099	53,101
AP119170C-9	11.2910.001.000	101
AP138271C-1	11.2780.510	--
AP138271C-2	11.2780.910	51
AP138271C-3	15.2780.870	51
AP138274C	59.2780.180.001	51
AP138274C-1	11.2780.520	--
AP140857C-1	59.2910.009.001	100
AP140857C-3	61.2910.005.001	101
AP140857C-4	61.2910.006.001	101
APAA-01976-4	11.3730.210H	22,50,92,99
APAA-01976-6	09.3200.360	--
APAA-01983-3	20.2710.500	--
P105367C15	20.2480.210H	103
P107424C10	20.2480.216H	50,62,99,103
P119170C-3	61.2910.003.001	101
P119170C-4	61.2910.004.001	101
P119170C8	15.2780.840	51,53,101
PAA01976-1	15.3731.326	50,99
PAA019762	15.3731.470H	22,50,99
PAA019763	15.2711.114	50,99
PAA019771	51.3732.326	50,99
PAA019774	15.2712.114	50,99
PAA-01985	09.3200.220	102
Renault		
261603141R	08.1047.001.099	77
261652475R	08.1047.002.099	77
501056290	61.3481.149H	23,76
5010578503	59.3900.123H	--
5010578504	59.3900.223H	--
5010578505	59.3901.123H	--
5010578506	59.3901.223H	--
5010578511	59.5580.247H	76
5010623057	20.3900.510H	74
5010623058	20.3900.520H	74
5010623231	59.3900.143H	--
5010623232	59.3900.243H	--
5010623246	59.3900.133H	--
5010623247	59.3900.233H	--
5010623689	59.3901.143H	--
5010623690	59.3901.243H	--
5010623698	59.3901.233H	--
7420849799	59.5524.748.099	--
7420849835	59.5524.649.099	76
7420849837	59.5524.648.099	76,81
7420849852	59.5524.640.099	--
7420850409	20.5520.250H	--
7420862779	11.3900.200H	74
7420862782	61.3900.100H	74
7420862795	15.3900.840H	74
7420862800	11.3910.200H	74
7420862809	61.3911.110H	74
7420862810	15.3911.871H	74
7420862812	08.5752.024.099	51,52,81
7420862813	61.3911.120H	74
7420862815	15.3911.872H	74
7420866665	61.3900.110H	74
7420866672	08.5752.024.099	51,52,81
7420903714	11.3900.201H	--
7420903722	58.3900.143H	74
7420903723	58.3900.133H	74

OE		
7420903727	58.3900.243H	74
7420903732	58.3900.233H	74
7420903745	15.3910.871H	74
7420903746	15.3910.872H	74
7420903880	11.3900.100H	74
7420903881	11.3900.101H	--
7420903882	11.3910.110H	74
7420903883	11.3910.120H	74
7420904268	61.3910.110H	74
7420904269	61.3910.120H	74
7420913815	61.3900.120H	28,74
7420914934	58.3900.333H	74
7420914938	58.3900.433H	74
7421020285	51.5524.930H	76,81,91
7421164788	59.5524.730.099	--
7421276373	61.3482.149H	23,76
7421326526	59.3900.233H	--
7421326527	59.3900.243H	--
7421326550	59.3900.223H	--
7421326551	59.3901.223H	--
7421326554	59.3901.233H	--
7421326558	59.3901.243H	--
7421346867	20.5520.250H	--
7421614025	09.3900.003.000	81
7421618499	85.752.024.099	74
7423227102	61.1000.007.199	75
7423229803	61.1000.006.199	75
7424382986	20.1000.611.199	75
7424382989	20.1000.614.199	75
7424384060	19.1000.603.199	75
7424384062	19.1000.601.199	75
7424384063	13.1000.601.199	75
7424384076	13.1000.603.199	75
7424384079	58.1000.611.199	75
7424384743	58.1000.641.199	75
7424384744	58.1000.621.199	75
7424384748	19.1000.602.199	75
7424384871	13.1000.602.199	75
7424384872	58.1000.614.199	75
7424384925	09.1000.400.199	75
7424384933	58.1000.624.199	75
7424384935	58.1000.612.199	75
7424384936	58.1000.642.199	75
7424384963	58.1000.622.199	75
7424384969	58.1000.613.199	75
7424486090	58.1000.623.199	75
7424486092	20.1000.613.199	75
7424680566	20.1000.612.199	75
7424680572	59.1000.611.199	75
7424680575	59.1000.612.199	75
7424680578	59.1000.613.199	75
7424680579	59.1000.614.199	75
7424680584	59.1000.641.199	75
7424680595	59.1000.642.199	75
7424680600	59.1000.621.199	75
7424680606	59.1000.622.199	75
7424680610	59.1000.623.199	75
7424680616	59.1000.624.199	75
7478493162	59.1025.003.099	--
7482226023	59.5524.640.099	--
7482226025	59.5524.648.099	76,81
7482226027	59.5524.649.099	76
7482265705	59.5524.748.099	--
7482408450	19.1033.001.199	74
7482408451	19.1033.002.199	74
7484531138	61.1000.105.199	75
7484531168	59.1025.001.099	25,76,84
7485120820	59.1025.002.099	25,76,84
7701057370	61.3	

Cross-reference-table Vergleichsliste nach OE-Nummern

OE		
1543451	51.2510.127H	36
1742422	09.3200.310H	--
1763444	51.1524.117	--
1767265	15.4001.740H	78
1805203	51.3732.326	50,99
1857128	59.2706.302	--
1880287	20.2710.121	99
1880288	20.2710.111H	99
1880289	59.2715.101.099	--
1880290	59.2715.102	--
1880295	20.2710.200H	50,99
1886454	40.2510.222H	38
1893487	51.3635.206	92
1893489	15.3802.840H	92
1893532	51.3731.326	50,99
1895048	51.3732.326	50,99
1915758	20.2700.260	--
1946640	15.2712.113F	99
2081428	55.3000.108H	--
2092223	55.2462.117	--
2092593	08.5752.024.099	51,52,74,75,81
2116023	56.1020.020.099	78
2116845	19.1019.013.099	79
2116846	19.1019.014.099	79
2116848	19.1019.313.099	79
2116849	19.1019.314.099	79
2118477	12.1020.003.099	78
2127721	55.2561.111.001	--
2239699	59.2706.005.001	--
22479890	11.2770.920	52
2248592	56.2660.002.099	37
2249381	19.1020.213.099	78
2249382	19.1020.613.099	78
2252649	58.2706.002.001	--
2252652	58.2706.104H	--
2332206	09.3200.320H	102
2382791	59.1005.003.099	78
2411114	59.2770.210.099	52
2434918	55.2561.111.001	--
2530656	09.2910.002.099	98,101
2530662	59.2910.004.001	100
2530663	59.2910.001.001	100
2537657	61.2910.009.002	--
2537709	11.2910.003.000	101
2537712	11.2910.011.002	101
2537714	19.2910.001.099	53,101
2537717	61.2910.011.002	101
2537719	11.2910.008.000	101
2537720	11.2910.012.002	101
2537722	61.2910.020.002	101
2537723	11.2910.017.000	101
2537726	61.2910.012.002	101
2541253	61.2910.005.001	101
2541254	11.2910.001.000	101
2541255	11.2910.002.000	101
2541259	61.2910.006.001	101
2541260	11.2910.006.000	101
2541261	11.2910.007.000	101
2541262	19.2910.002.099	53,101
2548189	15.2780.840	51,53,101
2556182	59.2782.120	--
2645660	56.1020.021.099	78
2657272	59.2910.010.001	100
2657275	59.2910.017.001	100
2657730	09.3200.330	--
2599501	61.2910.019.002	--
2599528	61.2910.010.002	--
2599529	11.2910.014.000	--
2599530	11.2910.016.000	--
2723896	59.2770.310.099	52
2728569	59.2770.211.099	52
2729143	59.1041.001.099	53
2729156	59.1042.003.099	53
2729158	59.1042.001.099	53
2739165	11.2770.102	52
2739167	15.2771.840	52
2739168	15.2771.870	52
2760509	59.2910.012.001	--
2794079	08.2910.001.002	52,101
2911918	09.1041.002.099	53
2926677	15.2780.870	51
3070159	51.3000.002.001	91
3070160	61.3000.004.001	91
3139595	08.1024.124.099	53
437489	51.2540.148	--
437491	58.2481.012	--
639093	14.2530.100	--
639141	61.2530.110H	54
9006839	05.3308.100	--
SIAC		
166351394	40.1009.004.099	95
166352077	40.1009.002.099	95
166428555 - ALT	51.1009.048.099	--
620031733 - ALT	59.1017.003.099	96
620031734 - ALT	59.1017.004.099	96
620102328 - ALT	51.1009.017.099	94
620102331 - ALT	51.1009.113.001	99
620102332 - ALT	51.1009.009.099	95
620120281 - ALT	58.1017.005.099	96
620120282 - ALT	58.1017.006.099	96

OE		
620120283 - ALT	58.1017.011.099	96
620120284 - ALT	58.1017.012.099	96
620186052	09.3200.420H	36,95,97
SOLARIS		
0000-059-207	11.2770.102	52
0000-059-214	11.2770.202	52
0000-059-216	11.2770.302	52
0000-059-218	11.2770.402	52
0000-059-220	11.2770.920	52
0000-059-224	61.2770.210	52
0000-059-226	61.2770.211	52
0000-059-281	15.2780.840	51,53,101
0000-059-284	15.2780.870	51
0000-059-305	11.2780.910	51
0000-077-177	09.3200.320H	102
0000-153-082	11.2770.620	--
0000-156-745	15.2771.840	52
0000-156-750	15.2771.870	52
0000-162-850	40.2660.404H	37
0000-183-182	59.2706.002.001	--
0000-183-225	59.2706.001.001	--
0000-184-272	20.2710.630	--
4800-000-541	20.2710.630	--
0000-217-083	58.2704.048	105
0000-217-090	20.2480.211H	103
0000-268-353	51.2461.117H	--
0000-291-449	15.2561.640	--
000-375-081	20.2700.260	--
0004-002-358	58.2704.086	105
0004-025-588	58.2704.059	--
0004-029-166	59.2770.211.099	52
0004-034-172	20.2710.620	50,51,103
0004-105-260	15.2561.600	--
0004-412-256	55.2561.010	--
1905.499.00	09.3200.220	102
1905-501-000	58.2704.065	--
1905-501-001	58.2704.090	--
1905-501-020	58.2704.059	--
1905-501-040	20.2710.720	--
190550200	51.3732.326	50,99
1905-502-001	59.2770.210.099	52
190550300	51.3731.326	50,99
1905-503-001	59.2780.120.099	51
1905-503-100	20.2780.630	--
1905-504-000	56.2661.147	--
1905-505-000	11.3001.100	--
1905-506-010	58.2704.093	105
1905-506-100	51.2530.148H	--
1905-508-000	58.2704.048	105
1905-508-001	58.2704.071	--
1905-509-000	58.2704.070	105
1905-509-025	58.2704.051H	105
1905-510-000	59.3652.167H	--
1905-511-000	59.2640.110H	--
1905-530-080	40.2530.422H	54
1905731470	15.3731.470H	22,50,99
1905770210	11.3730.210H	22,50,92,99
1905-770-210	11.3730.210H	22,50,92,99
1970018000	20.2480.216H	50,62,99,103
1970-018-000	20.2480.216H	50,62,99,103
1970-019-000	20.2480.217H	50,62,99,103
5300-008-114	15.2561.600	--
5300-009-015	11.2780.510	--
Steyr		
16100770103	51.2890.117H	92
Tatra		
443332041000	51.3300.149	--
443332042000	59.3601.128H	80
443332051000	51.3635.206	92
443332052000	51.3636.206	92
443332058000	51.3635.216	92
443332059000	51.3636.216	92
443400151000	51.3300.147H	92
990115703000	15.3802.840H	92
990115704000	40.3605.203H	80
Temsa		
5053APA03Y	61.2910.004.001	101
5053APA0401Y	15.2780.840	51,53,101
5053APA0403Y	19.2910.001.099	53,101
5053APA04Y	59.2910.002.001	100
5053APA05Y	61.2910.003.001	101
5053APA06Y	59.2910.001.001	100
HD301144-02Y	19.2910.002.099	53,101
HD3011444Y	59.2910.004.001	100
HD301151	61.2910.006.001	101
HD301152	61.2910.005.001	101
MD301145Y	59.2910.010.001	100
Terex		
103724	51.1523.121H	--
105518	55.2020.171	--
27230912	59.5524.530H	91
48092012	15.3802.840H	92
5253100003	51.3640.127	--
5653634760	51.1523.111H	--
5653634770	51.1524.118	--
5653634775	51.2500.127H	80
5653634816	51.2500.147H	80
5653634822	51.2493.137H	--

OE		
5653634825	51.1009.017.099	94
5653634830	51.1009.089.099	--
5653634836	40.1009.001.000	95
5653634837	40.1009.002.000	95
VDL		
20510114	51.2530.148H	--
24012180000	51.2530.128H	--
28250087	55.2561.110	--
30014897	59.2770.210.099	52
30014898	59.2780.120.099	51
30016869	11.2780.910	51
30017252	15.2780.870	51
30017729	59.2710.402H	99
30017737	51.3732.326	50,99
30017741	15.3731.470H	22,50,99
30017752	11.3730.210H	22,50,92,99
30017839	55.2561.010	--
30017840	15.2561.640	--
30017844	15.2771.870	52
30017845	20.2780.630	--
30017846	15.2780.840	51,53,101
30017876	15.2780.840	51,53,101
30022423	51.3731.326	50,99
30032132	55.2561.110	--
30045213	11.2770.202	52
30045214	11.2770.302	52
30045215	11.2770.402	52
30102976	20.2710.630	--
30103263	11.2780.510	--
30103281	61.2770.210	52
30103282	61.2770.211	52
30103284	11.2780.920	51
30103285	11.2780.520	--
30103286	59.2780.150.001	51
30110912	09.2910.006.001	--
30120778	59.2712.111	50
30120779	59.2712.114	50
30120780	20.2480.222	--
30120781	20.2480.221	--
30121356	59.2910.024.001	--
30121358	59.2910.023.001	--
30121380	61.2910.027.001	--
30121381	61.2910.026.001	--
30127115	59.2706.006.001	--
30130954	51.3635.206	92
30130955	15.3802.840H	92
30130962	11.2910.001.000	101
30130963	11.2910.006.000	101
30130964	11.2910.003.000	101
30130965	11.2910.008.000	101
30130967	11.2910.012.000	--
30130970	61.2910.009.002	--
30130971	61.2910.019.002	--
30130972	19.2910.001.099	53,101
30130975	61.2910.010.002	--
30130976	61.2910.020.002	--
30130977	11.2910.016.000	--
30130978	11.2910.017.000	--
30130979	11.2910.014.000	--
30130981	19.2910.002.099	53,101
30130982	61.2910.011.002	101
30130983	61.2910.012.002	101
30130985	11.2910.002.000	101
30130986	11.2910.007.000	101
30139755	59.2910.027.001	--
30162330	55.3000.117	--
30162331	61.3000.002.001	91
30172295	59.2760.007.001	--
30172762	11.2770.040	--
30172776	61.2770.900.099	52
30184984	61.2910.006.001	101
30184985	61.2910.005.001	101
30207377	59.2910.500.001	--
30218618	20.2760.140	--
30218619	20.2760.150	--
30218620	51.3636.206	92
30218738	09.2910.003.099	52,101
30218739	08.3950.001.099	52,101
30226914	12.1018.002.099	98
30226915		

Vergleichsliste nach OE-Nummern Cross-reference-table

OE			OE			OE		
331121	20.2710.121	99	22033845	12.1018.001.099	98	24384925	58.1000.624.199	82
1096643	59.3601.128H	80	22033846	12.1018.002.099	98	24384933	58.1000.612.199	82
1581550	51.2500.127H	80	22033847	15.2780.840	51,53,101	24384935	58.1000.623.199	82
1581599	40.2500.222H	80	22033849	19.1018.314.000	-	24384936	58.1000.622.199	82
1581602	40.2500.422H	80	22038103	09.2910.002.099	98,101	24384963	58.1000.613.199	82
1581616	51.2500.147H	80	22038110	08.3950.001.099	52,101	24384969	58.1000.623.199	82
1594411	51.2500.147H	80	22117132	11.2910.003.000	101	24486090	20.1000.613.199	82
1594412	51.2500.147H	80	22117135	11.2910.011.002	101	24486092	20.1000.612.199	82
1594415	40.2500.422H	80	22117164	61.2910.009.002	-	24680566	59.1000.611.199	82
1599462	51.2520.127H	80	22117179	19.2910.001.099	53,101	24680570	59.1000.612.199	82
1697007	40.2520.422H	80	22117189	15.2780.840	51,53,101	24680572	59.1000.613.199	82
1697927	14.2530.100	-	22117205	61.2910.011.002	101	24680575	59.1000.614.199	82
1697928	61.2530.110H	54	22117208	11.2910.008.000	101	24680579	59.1000.641.199	82
2739166	11.2770.920	52	22117209	11.2910.012.002	101	24680584	59.1000.642.199	82
3090395	51.2520.127H	80	22117212	61.2910.020.002	-	24680595	59.1000.621.199	82
3090734	40.3605.204F	80	22117213	11.2910.017.000	-	24680600	59.1000.622.199	82
3090737	15.3702.470H	80	22117218	19.2910.002.099	53,101	24680606	59.1000.623.199	82
3090739	15.3712.410H	-	22117220	61.2910.012.002	101	24680610	59.1000.624.199	82
3091756	15.3702.470H	80	22117238	11.2910.001.000	101	52510003	56.2630.127	-
3091757	15.3712.410H	-	22117239	11.2910.002.000	101	70309620	58.2705.001H	105
3092854	15.3702.470H	80	22117241	08.2910.001.002	52,101	70309627	51.3731.326	50,99
3093944	59.2715.101.099	-	22117451	59.2910.001.001	100	70309630	58.2704.059	-
3093945	59.2715.102	-	22117457	61.2910.007.001	-	70310107	56.2630.127	-
3098470	40.3640.422H	36,38	22183247	58.2704.090	-	70310110	11.1523.212	-
3126117	59.3602.128H	80	22200233	11.2910.006.000	101	70328278	59.2710.401H	99
6795142	51.2520.177	-	22200241	61.2910.019.002	-	70328289	59.2710.406	99
16281990	51.1009.025.099	94	22200250	61.2910.010.002	-	70328290	20.2710.121	99
16315898	55.2020.177H	-	22200257	11.2910.016.000	-	70328291	59.2706.104H	-
17452496	51.1009.017.099	94	22200281	11.2910.014.000	-	70328294	58.2704.070	105
20207881	59.3900.143H	-	22200293	11.2910.007.000	101	70331012	15.2712.114	50,99
20515454	20.2480.223	103	22200340	61.2770.003.002	-	70331060	58.2704.044	105
20523873	59.2710.410	-	22200342	61.2770.004.002	-	70331062	51.1524.117	-
20523877	59.2710.409	-	22210095	58.2704.048	105	70331063	51.2500.167H	-
20526284	09.3200.320H	102	22210161	58.2704.059	-	70331119	20.2700.240	-
20526353	56.2660.127H	37	22210206	58.2704.071	-	70331120	20.2700.230	-
20540638	20.2710.500	-	22210216	20.2480.221	-	70331122	20.2710.111H	99
20548032	56.2660.147H	37	22210899	58.2704.065	-	70331123	20.2480.217H	50,62,99,103
20548137	58.2600.010H	-	22212132	58.2705.002	-	70331124	20.2480.216H	50,62,99,103
20564284	58.2704.086	105	22212554	09.2910.003.099	52,101	70331940	59.2762.322	50
20567670	15.2240.840H	84	22274292	59.2770.310.099	52	70331941	20.2710.620	50,51,103
20707812	59.5580.247H	76	22274295	59.2780.120.099	51	70332172	58.2704.078	-
20707874	59.3900.133H	-	22329661	15.2561.640	-	70348000	59.2715.101.099	-
20707881	59.3900.143H	-	22360737	59.2910.015.001	100	70348001	59.2715.102	-
20708110	20.3900.510H	81	22360738	59.2910.016.001	100	70348002	20.2480.216H	50,62,99,103
20708230	20.3900.520H	81	22366228	59.2910.500.001	-	70348003	20.2480.216H	50,62,99,103
20708303	59.3900.233H	-	22479675	11.2780.910	51	70348066	09.3200.220	102
20743983	59.3900.243H	-	22479729	20.2780.630	-	70352000	58.2705.003	105
20849837	59.5524.648.099	76,81	22479736	11.2780.510	-	70352646	20.2480.210H	103
20854088	20.2480.211H	103	22479822	15.2780.870	51	70360528	20.2710.132D	-
20854564	15.3702.470H	80	22479887	11.2770.102	52	70360529	20.2480.222	-
20854568	15.3712.410H	-	22479899	11.2770.040	-	70360530	20.2710.200H	50,99
20854576	40.2520.422H	80	22479901	11.2770.520H	-	70360531	58.2710.101	-
20854583	40.3605.204F	80	22479903	61.2770.901.099	52	70360533	11.3730.210H	22,50,92,99
20862779	11.3900.200H	81	22479907	11.2770.202	52	70360534	20.2710.142D	-
20862782	61.3900.100H	81	22479912	15.2771.840	52	70360538	08.3491.325.000	-
20862795	15.3900.840H	81	22479913	15.2771.870	52	70369682	51.3732.326	50,99
20862800	11.3910.200H	81	22480056	11.2770.302	52	73028283	59.2710.402H	99
20862809	61.3911.110H	81	22480060	11.2770.402	52	82356808	13.1043.001.000	83
20862810	15.3911871H	81	22480148	61.2770.210	52	82356810	19.1000.101.099	83
20862812	08.5752.024.099	51,52,74,75,81	22480159	61.2770.900.099	52	82356824	19.1000.103.099	83
20862813	61.3911.120H	81	22480393	09.2770.110H	-	82359213	13.1043.001.000	83
20862815	15.3911.872H	81	22526136	59.2910.023.001	-	82359214	19.1000.102.099	83
20866665	61.3900.110H	81	22526143	59.2910.027.001	-	82417041	40.5725.412H	39,84
20866672	08.5752.024.099	51,52,74,75,81	22544279	59.2910.024.001	-	82417042	11.5721.001.099	39,84
20903722	58.3900.143H	81	22648216	61.2910.004.001	101	82417044	40.5735.403H	39,84
20903723	58.3900.133H	81	22836792	59.2910.007.001	100	82417045	11.5731.001.099	39,84
20903727	58.3900.243H	81	22838596	59.2760.007.001	-	82471688	61.5721.005.099	84
20903732	58.3900.233H	81	22847902	51.3635.206	92	82471689	61.5731.001.099	-
20914934	58.3900.333H	81	22847915	11.3730.210H	22,50,92,99	82471690	61.5721.006.099	84
20914938	58.3900433H	81	22847920	15.3802.840H	92	82472612	61.5721.004.099	39,84
20925244	08.3200.233H	51,52,98,101,102	23120356	58.2706.104H	-	84214269	61.1000.105.199	82
20970652	51.3850.197H	90	23200690	51.7504.044.001	91	84531138	59.1025.001.099	25,76,84
20970794	61.3000.002.001	91	23227102	61.1000.004.099	83	84531168	59.1025.002.099	25,76,84
21020285	51.5524.930H	76,81,91	23229803	61.1000.006.199	82	85104654	20.2700.260	-
21070768	15.2242.870H	-	23238988	20.2710.121	99	85104656	20.2700.200H	50,99
21083501	56.2600.147H	36	23286290	20.7504.044.001	91	85120820	61.3900.130H	81
21083541	09.2070.101H	36,38,54,80,92,102	23286294	20.7504.003.001	91	592710409	59.2710.409	-
21150393	55.2561.110	-	23329006	59.2910.006.001	100	703060536	15.2712.113F	99
21203313	59.3601.178H	80	23614948	20.2760.140	-	835002289	09.2070.101H	36,38,54,80,92
21310517	51.2480.150H	-	23614972	20.2760.150	-	8350026023	09.3400.440	-
21314080	55.3000.117	-	23655694	09.2710.200	-	8350035653	51.3731.326	50,99
21320365	15.2242.870H	-	23946968	59.2910.014.001	100	8350035654	51.3732.326	50,99
21320383	15.2240.840H	84	23946969	59.2910.013.001	100	8350035655	09.3200.220	102
21326526	59.3900.233H	-	24015370	19.1000.121.099	83	8350042502	59.2710.401H	99
21326527	59.3900.243H	-	24015373	19.1000.122.099	83	8350045482	20.2700.240	-
21386593	15.2712.113F	99	24018790	51.3000.002.001	91	8350045484	20.2700.230	-
21462625	58.2704.065	-	24018822	61.3000.004.010	91	8350046432	20.2480.217H	50,62,99,103
21475603	59.3900.233H	-	24382986	20.1000.611.199	82	8350046433	20.2710.200H	50,99
21614025	09.3900.003.000	81	24382989	20.1000.614.199	82	8350046555	11.3730.210H	22,50,92,99
21618499	85.752.024.099	81	24384060	19.1000.603.199	82	8350046557	15.2712.114	50,99
21879369	59.2910.001.001	100	24384062	19.1000.601.199	82	8350046970	20.2710.111H	99
21879404	59.2910.004.001	100	24384063	13.1000.601.199	82	8350046971	20.2480.216H	50,62,99,103
21885962	61.2910.005.001	101	24384076	13.1000.603.199	82	8690023211	40.3005.222	-
21885963	61							

Homologationsnummern List of homologation numbers

e	E	Typ · type tipo · тип	Тип · type tipo · тип	
II	e1	03*0002	575	56
IV	e1	03*0003	577	56
V	e5	02*0003	156/6 BO	--
IV	e11	03*0003	224	84
IV	E11	02*0003	224	84
V	e5	02*0004	156/6 BO	--
V	e11	03*0004	224	84
VI	e11	03*0005	224	84
VI	E11	02*0005	224	84
III	e1	03*0006	589	64,65,86,87
III	e1	03*0007	570	24
IV	e1	03*0008	571	24
IV	e1	03*0009	390	74,75,81
IV	e1	03*0010	390	74,75,81
V	e1	03*0011	558	76
V	e1	02*0013	379-1	--
IV	e1	03*0014	906	22
VVI	e1	03*0015	365-1	37
			394, 394-1	--
VI	e1	03*0016	389	91
VI	e1	03*0017	396	57,59
II	e1	03*0018	378-1	58
IV	e1	02*0019	377-1	55,58
II	e1	03*0022	271	50,99
			271-K	--
			276	50
			363	92
			373	22,40
			380-1	41
IV	e1	03*0023	386, 386-1	--
			381-1	41
			392-1	43
II	e1	03*0024	392-2	44
IV	e1	03*0025	393-1	43
IV	e1	03*0025	393-2	44
II	e1	03*0031	572	39,84
IV	e1	03*0032	573	39,84
V+VI	e1	03*0033	552-1	25,76,81,90,91
IV	e1	03*0037	390	74,75,81
V	e1	02*0039	360-1	80
VI	e1	03*0042	287-1 / 288-1	--
V	e1	03*0044	287-1 / 288-1	--
II	e1	03*0047	273	--
			395	62
II	e1	03*0048	340	36
II	e11	03*0050	400	78
II	E11	02*0050	400	78
IV	e11	03*0051	400	78
IV	E11	02*0051	400	78
II	e1	03*0060	364-1	--
II	E1	01*00620	273	--
			395	62
II	e1	03*0082	274	--
II	e1	03*0084	277	52
II	e1	03*0088	271	50,99
			271-K	--
			276	50
			363	92
			373	22,40
			380-1	41
II	e1	03*0097	580	45
IV	e1	03*0098	580	45
V	e1	03*0109	579	--
			39,42,44,45,57,59	--
II	e1	03*0115	380-1	41
II	e1	03*0123	375	55
			398	62
II	e1	03*0124	281	62
II	e1	03*0128	278	51
IV	e1	03*0129	278	51
V	e1	03*0174	395	62
II	e1	03*0184	348	23,76
V	e1	03*0185	348	23,76
II	e1	03*0188	374-1	--
IV	E5	01*019	156/6 BO	--
IV	e1	03*0196	559	25,27
VI	E5	01*020	156/6 BO	--
IV	e1	03*0234	371-1	--
II	e1	03*0242	1000-1	83
IV	e1	03*0243	1000-2	83
V	e1	03*0244	1001	--
VI	e1	03*0245	1002	--
II	e1	03*0257	385-1	--
II	E1	01*0376	258	--
II	E1	01*0377	258	--
II	e1	02*0382	385	90
II	e1	02*0384	349	63,85
II	E1	01*0384	349	63,85
II	e1	01*0391	282	--
II	e1	01*0392	283	--
IV	E1	01*0392	283	--
IV	e1	01*0394	367	--
IV	E1	01*0394	367	--
II	e1	01*0395	368	--
II	e1	02*0418	349	63,85
II	e1	01*0423	271	50,99
			276	50

e	E	Typ · type tipo · тип	Тип · type tipo · тип	
			363	92
			373	22,40
			380-1	41
II	E1	01*0423	271	50,99
			276	50
			363	92
			373	22,40
			380-1	41
IV	e1	02*0424	386, 386-1	--
			381, 386-1	--
IV	E1	01*0424	386, 386-1	--
			381	--
II	e1	02*0447	281	62
II	E1	01*0447	281	62
IV	e1	02*0448	281	62
II	E1	01*0448	281	62
IV	e1	02*0462	377	55,58
IV	E1	01*0462	377	55,58
II	e1	02*0463	378	58
II	E1	01*0463	378	58
V	e1	02*0464	379	--
V	E1	01*0464	379	--
II	e1	01*0469	385	90
II	E1	01*0469	385	90
II	e1	02*0487	372	--
IV	e1	02*0488	372	--
II	e1	02*0505	375	55
			398	62
II	E1	01*0505	375	55
			398	62
II	e1	02*0524	271	50,99
			276	50
			363	92
			373	22,40
			380-1	41
II	E1	01*0524	271	50,99
			276	50
			363	92
			373	22,40
			380-1	41
II	e1	02*0529	380-1	41
III	e1	02*0569	198	--
III	E1	01*0569	198	--
II	e1	02*0620	273	--
			395	62
II	e1	02*0646	392	42
II	E1	01*0646	392	42
IV	e1	02*0647	393	42
V	e1	02*0647	284	--
IV	E1	01*0647	393	42
II	e1	02*0662	374 (LDV)	--
II	e1	02*0688	405	--
IV	e1	02*0689	406	--
II	e1	02*0740	550	--
IV	e1	02*0741	551	--
V	e1	02*0742	552	25
V	E1	01*0742	552	25
II	e1	01*0798	901 (Iveco)	--
VVI	E1	02*0894	552-1	25,76,81,90,91
III	E1	02*0902	589	64,65,86,87
III	E1	02*0902	1039	68,69
III	E1	02*0902	1039	68,69
II	E1	02*0905	271	50,99
			276	50
			363	92
			373	22,40
			380-1	41
IV	E1	02*0906	906	22
II	E1	02*0910	274	--
V	E1	02*0912	558	76
IV	E1	02*0913	390	74,75,81
II	E1	02*0914	390	74,75,81
II	E1	02*0915	227	--
IV	E1	02*0916	390	74,75,81
IV	E1	02*0917	573	39,84
II	E1	02*0918	572	39,84
VVI	E1	02*0922	365-1	37
			394, 394-1	--
II	E1	02*0923	271	50,99
			276	50
			363	92
			373	22,40
			380-1	41
IV	E1	02*0924	393-1	43
IV	E1	02*0924	393-2	44
II	E1	02*0925	392-1	43
II	E1	02*0925	392-2	44
II	E1	02*0926	273	--
			395	62
II	E1	02*0929	580	45
IV	E1	02*0930	580	45
VI	E1	02*0937	389	91
II	E1	02*0939	380-1	41
II	E1	02*0941	375	55
			398	62
II	E1	02*0942	281	62
II	E1	02*0951	278	51

e	E	Typ · type tipo · тип	Тип · type tipo · тип	
IV	E1	02*0952	278	51
V	E1	02*0973	360-1	80
V	E1	02*0998	395	62
V	e1	*10025	156/4 BO	--
I	e1	02*10041	202	--
II	e1	*10042	152 AS	--
III	E1	02*1020	922, 923	--
V	e3	03*1021	463-1	--
V	E3	01*1021	463-1	--
III	E1	02*1021	922, 923	--
IV	e3	03*1022	462	--
IV	E3	01*1022	462	--
IV	E1	02*1023	348	23,76
V	e3	03*1031	1008	34,35
II	e3	03*1034	1008	34,35
IV	e1	02*1035	349 TW	63,85
IV	e3	03*1036	1008	34,35
VI	E1	02*1039	559	25,27
VI	e3	03*1042	1008	34,35
II	e3	09*1044	1048	--
			20,21,30,31,70,72,73	--
II	e9	01*1047	271	50,99
			276	50
			373	22,40
IV	e9	01*1054	386	22,40
II	e9	01*1063	460	--
II	e9	01*1073	271	50,99
			276	50
			373	22,40
IV	e9	01*1074	386	22,40
V	e9	01*1075	463-1	--
IV	e1	02*11001	260	36
II	e1	*11002	156/6 BO	--
IV	e1	02*11003	283	--
IV	e1	*11004	266	37
IV	e1	02*11005	268	--
IV	e1	*11006	267	--
IV	e1	02*11007	266	37
IV	E1	02*11008	266, 266-1	--
IV	E1	01*11008	266, 266-1	--
IV	E1	02*11008	266, 266-1	--
IV	e1	02*11009	266	37
IV	e1	02*11010	462	--
IV	E1	01*11010	462	--
IV	e1	02*11011	367	--
IV	E1	01*11011	367	--
IV	e1	02*11012	285	--
IV	E1	01*11012	285	--
IV	e1	02*11013	268	--
IV	e1	02*11014	267	--
IV	e1	*11015	266	37
IV	e1	02*11016	371	80
IV	E1	01*11016	371	80
II	e4	02*1104	110	--
II	E4	01*1104	110	--
II	e4	01*1106	257	--
II	E1	21108	1000	29,75,82,83
IV	E1	21109	1000	29,75,82,83
II	E1	02*1112	600	60
IV	E1	02*1113	600	60
VI	E1	02*1114	603	--
II	E1	02*1144	575	56
IV	E1	02*1145	577	56
II	e6	01*116	250	80
II	E1	02*1165	1009 / 1017	--
V	e9	04*11687	279	35
V	e9	04*11688	279	35
V	E1	02*1178	1014	--
V	E1	02*1178	1004	57,59,60
V	E1	02*1179	579	39,42,44,45,57,59
IV	e9	04*11853	279	35
II	e9	04*11854	279	35
V	e1	02*12001	156/5 BO	--
V	e1	*12002	156/2 BO	--
V	e1	02*12003	284	--
V	E1	01*12003	284	--
V	e1	*12004	156/6 BO	--
V	e1	*12005	265	37
V	e1	02*12006	265	37
V	e1	02*12007	265	37
V	E1	01*12007	265	37
V	e1	02*12008	265	37
V	e1	02*12009	463-1	--
V	E1	01*12009	463-1	--
II	e4	02*12011/1202	253	54
II	e4	02*12011/1202	254	54
II				

List of homologation numbers Homologationsnummern

e	E	Typ · type tipo · тип	Tip	
II	e1	02*14067	253	54
II	E1	01*14067	253	54
II	e1	01*14068	254	54
II	e1	01*14069	258	--
II	E1	01*14069	258	--
II	e1	01*14070	254	--
II	e1	01*14071	255	--
		256	--	--
II	e1	02*14072	258	--
II	e1	02*14073	404495222	--
		253	54	
II	e1	01*14075	251	38
II	e1	02*14076	152 AS	--
II	e2	02*14080	364	38
II	e1	02*14082	364	38
II	E1	01*14082	364	38
II	e1	02*14083	282	--
II	E1	01*14083	282	--
II	e1	02*14084	282	--
II	e1	*14085	340 / 341	--
II	e1	*14086	253	54
II	e1	02*14087	340 / 341	--
II	e1	02*14088	249 L	--
II	e1	02*14089	252	80
II	E1	01*14089	252	80
II	e1	02*14090	251	38
II	e1	*14091	253	54
II	e1	02*14092	254	54
II	e1	*14093	253	54
II	e1	*14094	253	54
II	e1	01*14095	254	54
II	e1	01*14096	253	54
II	e1	02*14097	258	--
II	E1	01*14097	258	--
II	e1	02*14098	340 / 341	--
II	E1	01*14098	340 / 341	--
II	e1	02*14099	254	54
II	e1	02*14100	330 / 331	--
II	E1	01*14100	330 / 331	--
II	e1	02*14101	340 / 341	--
II	e1	02*14102	460	--
II	E1	01*14102	460	--
II	e1	02*14103	461	--
II	E1	01*14103	461	--
II	e1	02*14105	368	--
II	e1	02*14108	254	54
II	e1	02*14109	254	54
II	e1	02*14111	385	--
II	e1	02*14112	258	--
II	e1	02*14117	280	--
II	E1	01*14117	280	--
II	e1	01*14119	249 L	--
II	e1	02*14121	366	--
II	e1	02*14122	364/1	--
II	e1	02*14123	368	--
II	E1	01*14123	368	--
II	e1	01*14124	340 / 341	--
II	e1	02*14125	370	80
II	E1	01*14125	370	80
II	e1	02*14126	371	80
II	E1	01*14126	371	80
II	e1	02*14142	364	38
II	E13	02*1456	38.3730.410H	--
IV	e13	03*1457	906	22
II	E1	41459	1036	96,97
II	E1	41469	1039	66,67
II	E1	41480	1041	53
II	E1	41481	1041	53
IV	E1	41482	1041	53
IV	E1	41540	1000	83
II	E1	41541	1000	83
IV	E1	41542	1024	46
II	E1	41543	1024	46
IV	e1	02*1550	264	--
V	e1	02*1551	264	--
II	E13	02*1558	253	54
II	e1	41619	1027	26
IV	E1	41620	1027	26
IV	E1	41620	1027	26
IV	E1	51696	1038	93
III	e1	01*17023	249 A	--
		249 K	63	
II	e1	*17087	151 K	--
III	e1	01*17098	249 A	--
		249 K	63	
II	e1	*17105	156/4 BO	--
II	e1	*17140	149 K	--
II	e1	01*17149	198	--
III	e1	01*17194	200 (Ford)	--
III	e1	02*17324	196	--
III	e1	02*17335	249 L	63
		*18792	572	39,84
II	e4	01*2067	254	54
II	e4	02*2069	259	--
II	E4	01*2069	259	--
II	E6	00*208	250	80
II	e4	01*2083	252	80

e	E	Typ · type tipo · тип	Tip	
II	e1	03*0242	1000	83
IV	e1	03*0243	1000	83
II	e1	*2407	244 A	--
II	e4	03*2563	373	22,40
II	E4	02*2563	373	22,40
II	e1	*2901	156/6 BO	--
II	e3	*30011	472	--
II	e3	*30595	467	--
II	e2	01*307	291	100,101
II	e3	*32806	467	--
II	e3	*32906	472	--
II	e3	*32908	474 (Iveco)	--
II	e3	*33488	473 (Iveco)	--
II	e3	*33491	472	--
II	e3	*34767	472	--
II	e3	*35216	472	--
II	e3	*35433	472	--
II	e3	*35911	474 (Iveco)	--
II	e3	01*36030	474 (Iveco)	--
II	e3	*36709	340 / 341	--
II	e3	*36710	473 (Iveco)	--
II	e3	*36726	600 (Fiat)	--
II	e11	01*3701	255	--
II	e11	01*3706	364	38
II	e11	01*3709	257	--
II	e11	01*3716	253	54
II	e11	01*3717	252	80
II	e3	*37469	475 (Iveco)	--
II	e3	*38090	472	--
III	e	01*38334	600 (Fiat)	--
II	e3	01*38662	475 (Iveco)	--
II	e3	01*3890	472	--
II	e3	02*3890	472	--
II	e3	01*38930	475 (Iveco)	--
II	e3	01*38961	475 (Iveco)	--
II	e3	01*39267	475 (Iveco)	--
II	e3	02*39267	475 (Iveco)	--
II	e3	01*39542	475 (Iveco)	--
II	e3	*40142	250	80
II	e3	01*40458	473 (Iveco)	--
II	e3	02*40458	473 (Iveco)	--
II	e3	01*40459	473 (Iveco)	--
II	e3	02*40459	473 (Iveco)	--
II	e1	*4051	253	54
II	E1	041427	1013	48,49,88,89
II	e3	*41511	475 (Iveco)	--
II	e3	01*41877	474 (Iveco)	--
II	e3	*42453	257	--
II	e3	01*42704	253	54
II	e3	01*42928	258	--
II	e3	02*43355	264	--
II	e3	02*43356	264	--
II	e3	02*43360	472	--
II	e3	*43611	364	38
II	E9	02*4395	286-1	--
II	e3	*44994	258	--
II	E9	02*4501	1047	77
II	E9	02*4507	1047	77
II	E9	24559	1033	74
IV	E9	24559	1033	74
II	e17	00*46002	257	--
II	e3	02*46315	472	--
II	e3	02*46656	460	--
II	E3	01*46656	460	--
V	e3	02*46657	463-1	--
IV	e3	02*46658	462	--
IV	E3	01*46658	462	--
II	e3	02*46919	461	--
II	E3	01*46919	461	--
IV/V	e11	01*5002	156/6 BO	--
II	e2	02*5004	348	23,76
IV/V	e13	01*51370	264	--
II	e11	01*5340	253	54
II	e11	01*5343	257	--
II	e11	01*5383	258	--
II	e11	01*5387	255	--
II	e11	01*5392	364	38
II	e11	01*5393	254	54
II	e11	01*5394	252	80
II	e11	01*5395	251	38
II	e11	01*5396	341	36
IV	e11	01*5398	261	--
IV	e11	01*5399	266	37
IV	e11	01*5420	260	36
II	e11	01*5421	249 L	63
V	e11	01*5422	265	37
II	e11	01*5464	254	54
IV/V	e11	01*5465	156/6 BO	--
III	e11	01*5502	200 (Ford)	--
II	e3	02*56297	348	23,76
II	E3	01*56297	470	--
II	e3	02*57571	461	--
II	E3	01*57571	461	--
II	e3	02*58121	460	--
II	E3	01*58121	460	--
IV	e3	02*58232	462	--
IV	E3	01*58232	462	--



MEKRA Lang GmbH & Co. KG hat diesen Katalog sorgfältig verfasst. Das Unternehmen enthebt sich jeglicher Verantwortung für eventuelle Fehler oder Auslassung hinsichtlich Schemen, Zeichnungen, Übereinstimmung mit O.E. Codes usw. und behält sich das Recht vor, ohne Ankündigung, am Inhalt Veränderungen vorzunehmen. Anmerkungen, Fehlerhinweise und weitere Anregungen seitens der Kunden werden gerne entgegen genommen, um die nächste Ausgabe des Kataloges effizienter zu gestalten.

Die Vervielfältigung, auch teilweise, des urheberrechtlich geschützten Inhalts des vorliegenden Kataloges ist ohne schriftliche Genehmigung durch die MEKRA Lang GmbH & Co. KG untersagt.

Sämtliche im Katalog genannten Sachnummern der Fahrzeughersteller und deren Markennamen sowie Prüfnummern anderer Spiegelhersteller dienen lediglich zu Vergleichszwecken.



MEKRA Lang GmbH & Co. KG has devoted its best attention to the editing of this catalogue; it nevertheless declines any responsibility for possible mistakes or omissions regarding figures, drawings, correspondence with O.E. codes etc. and it reserves the right to modify the contents without prior notice. Users' comments, reports of inaccuracies or any other suggestions which may in any way improve the next edition of this catalogue are warmly welcomed.

It is forbidden to reproduce, even partially, the contents of this catalogue without prior written consent of MEKRA Lang GmbH & Co. KG, who will protect its right in accordance with the law.

All vehicle manufacturers' reference numbers, mentioned in the catalogue, as well as their brand names and approval numbers of other mirror manufacturers are only for identification purposes.

Citroen Jumper

2006 - 2023

passend für • fitting for • approprié pour • para • adatto per • para • passar • vhodné pro • подходит для • kullanilabilinir • alkalmas • pasuje do

CITROEN

1048 **NEW** II e3 09★1044 **INTEGR.**

mm

1	59.1048.001.099		410 x 360 x 161	1613689280* 1613691980* 1635187780* 1685327280* 8154LR* 815428
	59.1048.002.099		410 x 360 x 161	1613693180* 1635685380
	59.1048.007.099		410 x 360 x 161	1611711480* 1650901780* 1685332280* 735690575* 735773338* 735773346
	59.1048.008.099		410 x 360 x 161	
	59.1048.009.099		410 x 360 x 161	1685327480
	59.1048.010.099		410 x 360 x 161	1666450680* 1685329880
	59.1048.011.099		410 x 360 x 161	1660711580* 1685327680
2	59.1048.003.099		485 x 430 x 170	1613692780* 1613693380* 1635193380* 1635685280* 1685330080* 8153PR* 8153Y0* 8154LZ
	59.1048.004.099		485 x 430 x 170	1613689480* 1635685780* 1685328180* 8153NS* 8153W3* 8154KV* 815430
	59.1048.005.099		485 x 430 x 170	1613692780* 1635685280* 8153PL* 8153X6* 8154LZ* 815459
	59.1048.006.099		485 x 430 x 170	1611711880* 1635683380* 1635683380* 8153PE* 8153X2* 8154PH* 815439
1 + 2	19.1048.001.099		269 x 193 x 29	8151LJ
	19.1048.002.099		269 x 193 x 29	8151LK
	19.1048.003.099		77 x 187 x 24	8151LP
	19.1048.004.099		77 x 187 x 24	8151LQ
	19.1048.005.099		269 x 193 x 29	1666450580* 1666450680
	19.1048.006.099		269 x 193 x 29	735706880* 735706881* 735706882 735706684* 735706885* 765706886
	08.1048.001.099		130 x 71 x 60	6325H3
	08.1048.002.099		130 x 71 x 60	6325H4
	08.1048.003.099		130 x 71 x 60	1688409580
	08.1048.004.099		130 x 71 x 60	1688409680



1



2

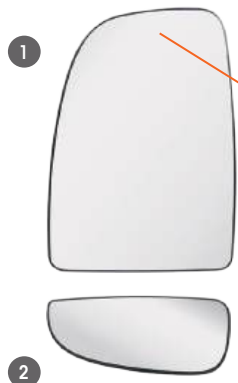

Blind Spot Modul

Das Blind Spot Modul ist im Lieferumfang enthalten.
The Blind Spot Modul is included in the delivery!



DAF

65 CF, 75 CF,
85 CF, 95 XF
alternativ 75 / 85 / 95
03/00 - 04/06
09/92

DAF

373	II [e1] 02★0423 II (E1) 010423			Ø 28 mm
------------	-----------------------------------	--	--	---------

MEKRA LANG Group	Beschreibung description descripção descrizioone descripção benjämning Popis omrcaavre öreljik leirats opis		OE	
61.3730.324H		384 x 205 x 120	1425 104	1610 186
15.3731.470H		369 x 190 x 42	1425 109	1610 190
11.3730.210H		367 x 187 x 60	1425 113	
61.3730.326H		384 x 205 x 120	1425 105	1610 184
15.3731.470H		369 x 190 x 42	1425 109	1610 190
11.3730.210H		367 x 187 x 60	1425 113	



386 386-1	IV [e1] 02★0424 IV (E1) 010424 IV [e1] 03★0023			Ø 28 mm
----------------------------	--	--	--	---------

MEKRA LANG Group	Beschreibung description descripção descrizioone descripção benjämning Popis omrcaavre öreljik leirats opis		OE	
61.3860.214H		219 x 170 x 120	1425 108	1610 187
15.3861.114H		203 x 154 x 36	1425 111	1610 191
11.3860.500H		203 x 154 x 60	1425 114	
61.3865.124H		219 x 170 x 120	1610 189	
15.3862.174H		203 x 154 x 36	1610 182	
11.3860.500H		203 x 154 x 60	1425 114	



906	IV [e1] 03★0014			Ø 28 mm
------------	-----------------	--	--	---------

MEKRA LANG Group	Beschreibung description descripção descrizioone descripção benjämning Popis omrcaavre öreljik leirats opis		OE	
61.9065.114H		209 x 218 x 136	1670 877	
15.9060.870H		204 x 195 x 58	1670 878	
11.9060.100H		202 x 194 x 55	1670 888	
56.9065.110		209 x 218 x 136		
15.9060.870H		204 x 195 x 58	1670 878	
11.9060.100H		202 x 194 x 55	1670 888	
61.3860.100		210 x 9 ø		



DAF

03/00 - 05/06

348	II 03★0184 II 021022		Ø 22 mm
	Beschreibung description description description benamning popis özvejlík leirás opis		OE
61.3481.149H		395 x 205 x 145	1805 714
15.3480.840H		372 x 189 x 32	1805 717
11.3480.100		169 x 88 x 27	
61.3480.149H		382 x 193 x 85	1405 295 ♦ 1805 712 1404 871
40.3485.412H		375 x 190 x 3	1805 713

LF 45/55



348	IV 03★0185 IV 021023		Ø 22 mm
	Beschreibung description description description benamning popis özvejlík leirás opis		OE
61.3482.149H		199 x 199 x 97	1796 324 ♦ 1404 868 1405 350
40.3485.403H		191 x 191 x 3	1796 325 ♦ 1404 849



DAF

DAF

XF 95, XF 105, XF 106
CF 65/75/85
JOHN DEERE

01/06
05/06
10/11



XF 95, XF 105, XF 106

02/13

DAF

570	II e1 03★0007 II E1 02 1251			Ø 40 mm
	Beschreibung description description descriçáo descrizione descripciön benämning popis omivcawre özellik leirats opis		mm	OE
61.5700.210H		411 x 228 x 140	1692 557	
61.5700.310.099		411 x 228 x 140	1812 862 ÷ 1689 348	
15.5701.840H		363 x 177 x 25	1685 330 AL 20 31 51 (John Deere)	
11.5700.100H		411 x 228 x 110	1644 325	
09.5700.001.099		250 x 6 ø		

571 574	IV e1 03★0008 IV E1 02 1252 IV E1 02 1253			Ø 40 mm
	Beschreibung description description descriçáo descrizione descripciön benämning popis omivcawre özellik leirats opis		mm	OE
EURO 5				
61.5710.210H		239 x 221 x 140	1692 556	
61.5710.310.099		239 x 221 x 140	1817 860 ÷ 1689 347	
15.5711.870H		207 x 161 x 35	1685 331	
11.5710.110H		239 x 221 x 118	1644 326 ÷ 1659249	
09.5700.002.099		250 x 6 ø	1812 865	
EURO 6				
61.5710.310.099		239 x 221 x 140	1817 860 ÷ 1689 347	
15.5711.870H		207 x 161 x 35	1685 331	
11.5710.110H		239 x 221 x 118	1644 326 ÷ 1659249	
61.5740.001.099		245 x 243 x 140	1940 341	
19.5740.311.099		211 x 192 x 40	1940 342	
12.5740.002.099		245 x 240 x 118	1882 113	

XF 95, XF 105, XF 106
CF 65/75/85

11/09
11/09



559	VI E1 021039 VI e1 03★0196			INTEGR.
	Beschreibung description description descriçáo descrizione descripciön benämning popis omivcawre özellik leirats opis		mm	OE
XF				
59.5595.235H		411 x 375 x 285	1684 042 ÷ 1816 912	
59.5595.236		411 x 375 x 285	1684 043 ÷ 1816 913	
XF				
59.5595.331H		1007 x 320 x 220	1684 046 ÷ 1816 914	
59.5595.332		1007 x 320 x 220	1684 047 ÷ 1816 915	
CF				
59.5595.131H		437 x 433 x 383	1684 030 ÷ 1816 902	
59.5595.132H		437 x 433 x 383	1684 031 ÷ 1816 903	
61.5590.001.099		256 x 165 x 82	1830 338	
20.5521.100H		110 x 53 x 51	1698 180	

DAF

570 A		ALU		Ø 40 mm	
MEKRA LANG Group		Beschreibung description descripção descrizione benamning popis описанье leírás opis		mm	
		OE			
58.5701.104.099		818 x 40 Ø	1685 324	1812 867	XF EURO 5
58.5700.001.099		818 x 40 Ø	1685 325	1830 562	XF EURO 5
58.5700.003.099		818 x 40 Ø	1940334		CF EURO 6
58.5700.004.099		818 x 40 Ø	1940335		CF EURO 6
58.5713.114.099		920 x 40 Ø	1788 972	1812 859	CF
58.5710.001.099	t. sensor	920 x 40 Ø	1788 487	1818 353	CF
20.5700.410H	1	145 x 98 x 68	1644 324		XF EURO 5
20.5700.420H	1	145 x 98 x 68	1644 323		XF EURO 5
12.5700.001.099	2	304 x 113 x 82	1882 126		XF EURO 6
12.5700.002.099	3	205 x 78 x 45	1882 111		XF EURO 6
12.5700.003.099	2	304 x 113 x 82	1882 127		XF EURO 6
12.5700.004.099	3	205 x 78 x 45	1882 112		XF EURO 6



XF 95, XF 105, XF 106
CF 65/75/85
01/06
05/06

552 552-1		V e1 02★0742 V VI e1 03★0033 V VI (E) 020894		Truck ABS	
MEKRA LANG Group		Beschreibung description descripção descrizione benamning popis описанье leírás opis		mm	
		OE			
59.5520.230H		319 x 187 x 50	1669 573		XF
59.5520.130H		319 x 187 x 50			CF



1005		V e1 04★1336 V (E) 041336		Truck ABS	
MEKRA LANG Group		Beschreibung description descripção descrizione benamning popis описанье leírás opis		mm	
		OE			
59.1005.001.099		326 x 202 x 214	1949 304		CF
59.1005.002.099		326 x 202 x 214	1949 305		XF

New Regulation ECE R46/04



1025		V e1 04★1345		Truck ABS	
MEKRA LANG Group		Beschreibung description descripção descrizione benamning popis описанье leírás opis		mm	
		OE			
59.1025.001.099		315 x 179 x 220	1709 390		LF
59.1025.002.099		315 x 179 x 220	1709 389		LF

LF 45/55

New Regulation ECE R46/04



DAF

*XD/XF/XG/XG+
New Generation*

10/2020



DAF

1027	II (E1) 041619 IV (E1) 041620			INTEGR.
-------------	----------------------------------	--	--	---------

Beschreibung
description
description
descripção
descripção
benämning
popis
opis
opis

mm

LHD	59.1027.001.099		1014 x 397 x 200	2248 157 + 2424 898	
	59.1027.002.099		1014 x 414 x 258	2248 158 + 2424 899	
	RHD	59.1027.003.099		1014 x 414 x 258	2248 175 + 2352 946 + 2424 900
		59.1027.004.099		1014 x 397 x 200	2248 176 + 2424 901
a	12.1027.005.099	für für main mirror	1	701 x 248 x 154	2248 166
	12.1027.107.099	für für main mirror	2	701 x 248 x 154	2248 172
	12.1027.207.099	für für main mirror	3	701 x 248 x 154	2298 826
	12.1027.006.099	für für main mirror	4	701 x 248 x 154	2248 167
	12.1027.108.099	für für main mirror	5	701 x 248 x 154	2248 173
	12.1027.208.099	für für main mirror	6	701 x 248 x 154	2298 827
b	12.1027.001.099	für für upper foot	7	205 x 103 x 98	2248 164
	12.1027.002.099	für für upper foot	8	205 x 103 x 98	2248 165
c	12.1027.103.099	für für lower foot	9	266 x 177 x 114	2248 160 + 2424 902
	12.1027.203.099	für für lower foot	10	266 x 177 x 114	2298 758 + 2424 904
	12.1027.104.099	für für lower foot	11	266 x 177 x 114	2248 161 + 2424 903
	12.1027.204.099	für für lower foot	12	266 x 177 x 114	2298 759 + 2424 905
d	19.1027.011.099	1200 24 V	13	384 x 200 x 42	2306 590
	19.1027.012.099	1200 24 V	14	384 x 200 x 42	2306 591
	19.1027.311.099	300 24 V	15	209 x 210 x 52	2306 592
	19.1027.312.099	300 24 V	16	209 x 210 x 52	2306 593
	12.1027.015.099	für für neck	17	176 x 164 x 79	2248 168
	12.1027.016.099	für für neck	18	176 x 164 x 79	2248 169
	61.1029.224.099	für für	19	130 x 125 x 50	2306 586
	61.1024.224.099	für für	20	130 x 125 x 50	2306 587

a



b



c



d

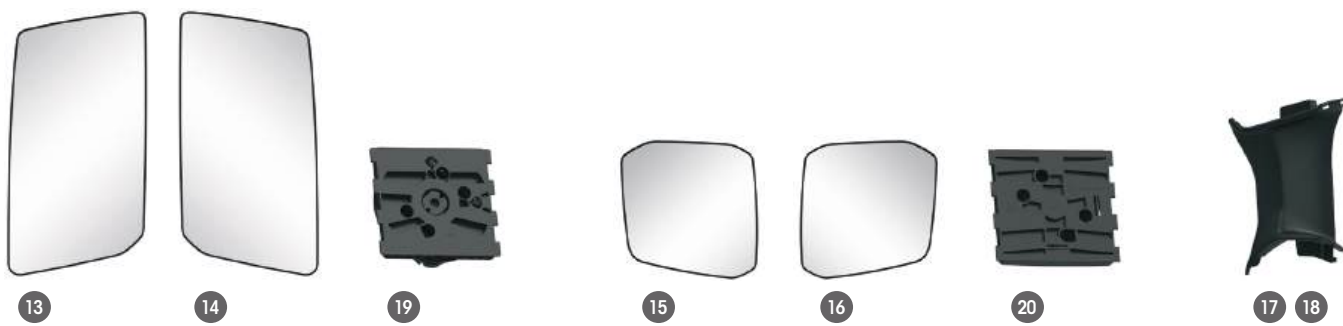

black

DAF

559	VI (E1) 021039			INTEGR.
	VI (e1) 03★0196			
	Beschreibung description description description benämning poris описание izveik veikš opis		OE	
59.5590.013.099		450 x 491 x 217	2248 178 + 2346 204 + 2415 378	
59.5590.014.099		450 x 491 x 217	2248 179 + 2346 205 + 2415 379	
12.5590.009.099	1	209 x 128 x 70	2248 184	

*XD/ XF / XG / XG+
New Generation*

10/2020



1005	V (e1) 04★1336			
	V (E) 041336			
	Beschreibung description description description benämning poris описание izveik veikš opis		OE	
59.1005.011.099		330 x 233 x 205	2248 159	
12.1005.001.099	2	121 x 78 x 52	2248 174	

*XD/ XF / XG / XG+
New Generation*

10/2020



DAF

05/2006 - 01/2024

DAF

390

II [E] 03★0009
 II [E] 020914
 IV [E] 03★0010
 IV [E] 020913



Ø 28 mm



Beschreibung
 description
 descrio
 descrio
 descripción
 benaming
 popis
 omicaime
 бэйлік
 opis



OE



2



1



Part Number	Icons	Dimensions (mm)	OE Part Number
58.3900.143H	[C] [L] [R] [S]	800 x 270	1733892
58.3900.243H	[C] [L] [R] [S]	800 x 270	1733893
58.3900.133H	[C] [L] [R] [S]	800 x 350	1736954
58.3900.233H	[C] [L] [R] [S]	800 x 350	1736953
58.3900.333H	[C] [L] [R] [S]	800 x 350	1736952
58.3900.433H	[C] [L] [R] [S]	800 x 350	1736951
15.3900.840H	[L] [R] [S] [24V] [1200]	337 x 202 x 25	1737933
15.3911.871H	[L] [R] [S] [24V] [300]	200 x 197 x 75	1736879
15.3911.872H	[L] [R] [S] [24V] [300]	200 x 197 x 75	1736865
61.3900.100H	[L] [R] [S] [2]	373 x 245 x 101	1735521
61.3900.110H	[L] [R] [S] [2]	373 x 245 x 101	1735519
61.3900.120H	[L] [R] [S] [2]	373 x 245 x 101	1735520
61.3902.110H	[L] [R] [S] [24V] [1200]	373 x 245 x 101	1781224
61.3902.120H	[L] [R] [S] [24V] [1200]	373 x 245 x 101	1781225
61.3900.130H	[L] [R] [S] [für pour] [2]	373 x 245 x 101	1545467
61.3911.110H	[L] [R] [S] [1]	245 x 236 x 105	1735522
61.3911.120H	[L] [R] [S] [1]	245 x 236 x 105	1735523
61.3913.110H	[L] [R] [S] [24V] [300]	245 x 236 x 147	1781227
61.3913.120H	[L] [R] [S] [24V] [300]	245 x 236 x 147	1781228
11.3900.200H	[L] [R] [S]	371 x 244 x 80	1736884
11.3910.200H	[L] [R] [S]	244 x 225 x 75	1736883
08.5752.024.099	[L] [R] [S]	130 x 120 x 53	1904296
20.3900.510H	[für pour] [L] [R] [S]	518 x 160 x 98	1736924
20.3900.520H	[für pour] [L] [R] [S]	518 x 160 x 98	1736923

DAF

1000 **NEW** II (E) 021108 IV (E) 021109 INTEGR.

Beschreibung description descrição descrição descrição benámining P-papais omlrcawwe öreilikk leirras optis mm

59.1000.611.199		24 V kurz short	1	890 x 439 x 180	2363198
59.1000.612.199		24 V kurz short	1	890 x 441 x 180	2363200
59.1000.613.199		24 V kurz short	1	890 x 439 x 180	2363202
59.1000.614.199		24 V kurz short	1	890 x 441 x 180	2363204
59.1000.641.199		24 V mittel medium	1	890 x 490 x 180	
59.1000.642.199		24 V mittel medium	1	890 x 483 x 180	2363207
59.1000.621.199		24 V lang long	1	890 x 539 x 180	2363212
59.1000.622.199		24 V lang long	1	890 x 530 x 180	2363214
59.1000.623.199		24 V lang long	1	890 x 539 x 180	2363216
59.1000.624.199		24 V lang long	1	890 x 530 x 180	2363218
58.1000.611.199		kurz short	1	890 x 439 x 28 ø	2436404
58.1000.612.199		kurz short	1	890 x 441 x 28 ø	2436405
58.1000.613.199		kurz short	1	890 x 439 x 28 ø	2436406
58.1000.614.199		kurz short	1	890 x 441 x 28 ø	2436407
58.1000.641.199		mittel medium	1	890 x 490 x 28 ø	2436412
58.1000.642.199		mittel medium	1	890 x 483 x 28 ø	2436413
58.1000.621.199		lang long	1	890 x 539 x 28 ø	2436408
58.1000.622.199		lang long	1	890 x 530 x 28 ø	2436409
58.1000.623.199		lang long	1	890 x 539 x 28 ø	2436410
58.1000.624.199		lang long	1	890 x 530 x 28 ø	2436411
61.1000.105.199		KIT	9	81 x 76 x 45	2430046
61.1000.006.199		KIT	7	130 x 127 x 65	2430047
61.1000.007.199		KIT 24 V	8	130 x 127 x 65	2430048
13.1000.601.199			3	393 x 210 x 46	2430049
13.1000.602.199			3	393 x 210 x 46	2430050
13.1000.603.199			5	210 x 208 x 54	2430051
19.1000.601.199		24 V 1200	2	387 x 205 x 41	2430052
19.1000.602.199		24 V 1200	2	387 x 205 x 41	2430053
19.1000.603.199		24 V 300	4	205 x 205 x 55	2430054
09.1000.400.199		temperature sensor		215	
20.1000.611.199		für for pour	6	519 x 160 x 100	2430055
20.1000.612.199		für for pour	6	519 x 160 x 100	2430056
20.1000.613.199		für for pour t. sensor	6	519 x 160 x 100	2430057
20.1000.614.199		für for pour t. sensor	6	519 x 160 x 100	2430058

DAF XB/XBC/XB Electric 01/2024

DAF



6

7

8

9

Fiat Ducato

2006 - 2023



1048	NEW	II e3 09★1044			INTEGR.
-------------	------------	---------------	--	--	----------------

	Beschreibung description description descriçãõ descriçãone benápmning popis omivcawne bùeillik opis		
--	--	--	--

1	59.1048.001.099		410 x 360 x 161	735440388* 735480916* 735517068* 8154LR
	59.1048.002.099		410 x 360 x 161	735440423* 735480940* 735517079
	59.1048.007.099		410 x 360 x 161	735588248* 71778662* 735661835* 735773338
	59.1048.008.099		410 x 360 x 161	735706891* 735773387* 1685329780
	59.1048.009.099		410 x 360 x 161	735706880* 735773348
	59.1048.010.099		410 x 360 x 161	735706895* 735773396
	59.1048.011.099		410 x 360 x 161	735706884* 735773357* 1660711580* 1685327680

2	59.1048.003.099		485 x 430 x 170	735480936* 735517075* 735424425* 735424433* 735440419* 735440425
	59.1048.004.099		485 x 430 x 170	735440390* 735480889* 735517043* 735620711* 735661846* 735661853* 73566846* 735773372
	59.1048.005.099		485 x 430 x 170	71778713* 73542443* 735440419* 73544042* 735480942* 735517081* 735620753* 735661887* 735773405
	59.1048.006.099		485 x 430 x 170	7177866* 735588252* 735661853* 735773372

1 + 2	19.1048.001.099		①	269 x 193 x 29	71748246
	19.1048.002.099		①	269 x 193 x 29	71748247
	19.1048.003.099		②	77 x 187 x 24	71748250
	19.1048.004.099		②	77 x 187 x 24	71748251
19.1048.005.099		③	269 x 193 x 29	6000632355	
19.1048.006.099		③	269 x 193 x 29	6000632356	
08.1048.001.099		④	130 x 71 x 60	71748254	
08.1048.002.099		④	130 x 71 x 60	71748255	
08.1048.003.099		⑤	130 x 71 x 60	6000626718* 6000626717* 6000633331	
08.1048.004.099		⑤	130 x 71 x 60	6000626717* 6000626718* 6000633330	



Blind Spot Modul

Das Blind Spot Modul ist im Lieferumfang enthalten.
The Blind Spot Modul is included in the delivery!

FIAT

1048	NEW	II e3 09★1044			INTEGR.
-------------	------------	---------------	--	--	---------

MEKRA LANG Group		Beschreibung description description description benaming popis opis opis			mm		OE
59.1048.012.099		t-sensor	410 x 360 x 161	735782747	1		
59.1048.013.099			410 x 360 x 161	735782722			
59.1048.014.099			410 x 360 x 161	735782723			
59.1048.015.099		t-sensor	485 x 430 x 170	735782763	2		
59.1048.016.099			485 x 430 x 170	735782741			
19.1048.001.099		1	269 x 193 x 29	71748246	1 + 2		
19.1048.002.099		1	269 x 193 x 29	71748247			
19.1048.003.099		2	77 x 187 x 24	71748250			
19.1048.004.099		2	77 x 187 x 24	71748251			
19.1048.005.099		3	269 x 193 x 29	6000632355			
19.1048.006.099		3	269 x 193 x 29	6000632356			
08.1048.003.099		5	130 x 71 x 60	6000626718 + 6000626717 + 6000633331			
08.1048.004.099		5	130 x 71 x 60	6000626717 + 6000626718 + 6000633330			

Fiat Ducato



1



Blind Spot Modul

Das Blind Spot Modul ist im Lieferumfang enthalten.
The Blind Spot Modul is included in the delivery!



4



2

2019 →

Transit



1



2



1 2

Anschlusskabel ab Bj. 2019, 12-Polig
Connection cable from year 2019, 12-pin

FORD

1049	II E9 03★6909			INTEGR.
	II E9 03★6950			

	Beschreibung description description description benámení popis opis opis opis	 mm	OE
--	--	--------	-----------

1	59.1049.009.099					380 x 385 x 275	2366799			
	59.1049.010.099					380 x 385 x 275	2365911			
	59.1049.003.099					380 x 385 x 275	2366803			
	59.1049.004.099					380 x 385 x 275	2365917			
	59.1049.005.099					380 x 385 x 275	2365947			
	59.1049.006.099					380 x 385 x 275	2365898			
	59.1049.007.099					380 x 385 x 275	2365950			
	59.1049.008.099					380 x 385 x 275	2365901			
	08.1049.001.099		5 W			150 x 95 x 60	2085655			
	08.1049.002.099		5 W			150 x 95 x 60	2043755			
2	59.1049.001.099					500 x 405 x 225	KK3117683LB5JA + 2366812			
	59.1049.002.099					500 x 405 x 225	KK3117682LB5JA + 2365929			
	08.1049.003.099		16 W			150 x 95 x 60	2208678			
	08.1049.004.099		16 W			150 x 95 x 60	2085657			
1 + 2	19.1049.001.099					223 x 180 x 20	1823986			
	19.1049.002.099					223 x 180 x 20	1823995			
	19.1049.003.099					223 x 180 x 20	1823994			
	19.1049.004.099					223 x 180 x 20	1823985			
	19.1049.005.099					175 x 92 x 20	1855103			
	19.1049.006.099					175 x 92 x 20	1855102			

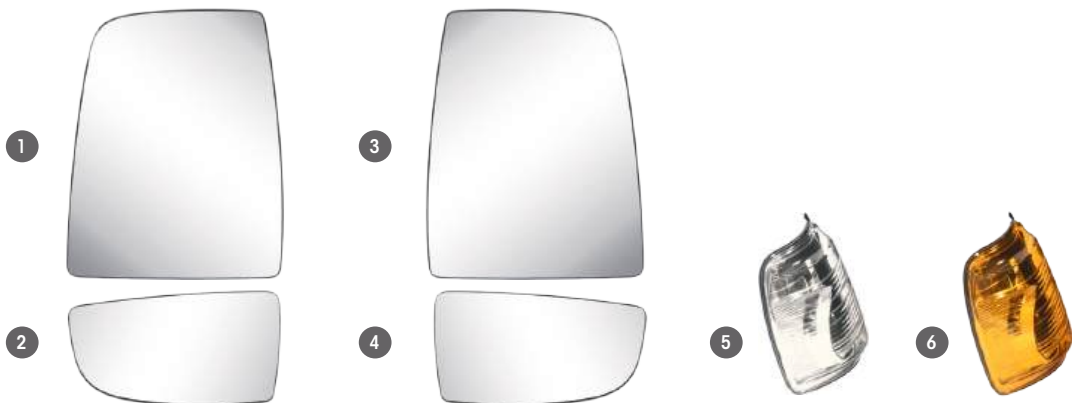

FORD

1049	II E9 03★6909			INTEGR.
	II E9 03★6950			

	Beschreibung description descripción descrizione benámenning popis omycaawie бэйлік opis		OE

Part No.	Icons	Dimensions (mm)	Part No.	Quantity
59.1049.011.099		380 x 385 x 275	BK31-17683-JJ5J6A	1
59.1049.012.099		380 x 385 x 275	BK31-17682-JJ5J6A	
59.1049.013.099		380 x 385 x 275	1911158 ♦ BK31-17683-NA5JA	
59.1049.014.099		380 x 385 x 275	1911141 ♦ BK31-17682-NA5JA	
19.1049.001.099		223 x 180 x 20	1823986	1
19.1049.002.099		223 x 180 x 20	1823995	3
19.1049.003.099		223 x 180 x 20	1823994	1
19.1049.004.099		223 x 180 x 20	1823985	3
19.1049.005.099		175 x 92 x 20	1855103	2
19.1049.006.099		175 x 92 x 20	1855102	4
12.1049.001.099		355 x 265 x 65	1823809	
12.1049.002.099		355 x 265 x 65	1823808	
08.1049.001.099		150 x 95 x 60	2085655	5
08.1049.002.099		150 x 95 x 60	2043755	5

Transit



1



1

Anschlusskabel ab Bj. 2013-2019, 8-Polig
 Connection cable from year 2013-2019, 8-pin

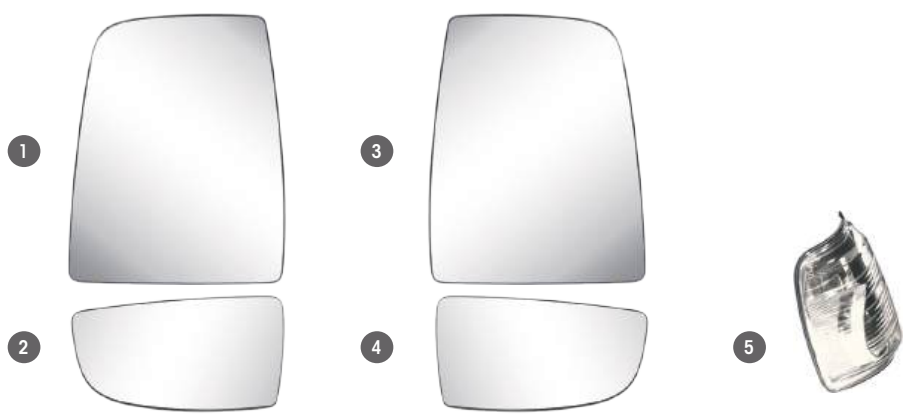

Stralis
Trakker
Eurocargo
Tector

04/06
04/06
04/06
04/06



IVECO

1008		II e3 03★1034 IV e3 03★1036	Truck II+IV	ABS	INTEGR.
MEKRA LANG Group		Beschreibung description descripción descrizione benamning Popis omivcenne üzellik opis	mm		OE
59.1008.005.099		799 x 370 x 272	504 150 526 ÷ 504 369 910 580 133 4614		
59.1008.006.099		799 x 370 x 272	504 150 527 ÷ 504 369 961 580 133 4610		
59.1008.045H*		799 x 370 x 272	504 150 532		
59.1008.046H*		799 x 370 x 272	504 150 533		
59.1008.011.099		799 x 424 x 287	504 150 538 ÷ 504 370 048 580 133 6285		
59.1008.012.099		799 x 424 x 287	504 150 539 ÷ 504 370 055 580 133 6298		
59.1008.051H*		799 x 424 x 287	504 150 544		
59.1008.052H*		799 x 424 x 287	504 150 545		
59.1008.017.099		811 x 520 x 304	504 150 551 ÷ 504 369 979 580 134 1206		
59.1008.018.099		811 x 520 x 304	504 150 552 ÷ 504 369 995 580 134 1207		
59.1008.057H*		811 x 520 x 304	504 150 557		
59.1008.058H*		811 x 520 x 304	504 150 558		
19.1008.041.099		371 x 181 x 15	504 197 878		
19.1008.311.099		192 x 206 x 20	504 197 879		

* only available in UK/IRL



1008		V e3 03★1031	Truck V	ABS	
MEKRA LANG Group		Beschreibung description descripción descrizione benamning Popis omivcenne üzellik opis	mm		OE
56.1008.002.099		270 x 230 x 60	504 168 236		
56.1008.003.099*		270 x 230 x 60	504 168 237		
56.1008.004.099*		270 x 230 x 60	504 168 238		
11.1008.001.099		210 x 205 x 100	504 168 244		

* only available in UK/IRL

IVECO

1008	VI e3 03★1042			INTEGR.
	Beschreibung description descripção descrizione benamining popis onycauwe őzeilijk leírás opis		OE	
55.1008.002.099		315 x 240 x 60	504 224 428	
55.1008.003.099*		315 x 240 x 60	504 224 429	
55.1008.004.099*		315 x 240 x 60	504 224 430	

* only available in UK/IRL

Stralis
Trakker
Eurocargo
Tector



04/06 - 2019
04/06
04/06
04/06

279	II e4 04★11854 IV e4 04★11853 V e4 04★11687 V e4 04★11688			INTEGR.
	Beschreibung description descripção descrizione benamining popis onycauwe őzeilijk leírás opis		OE	
19.2790.011.099		399 x 222	500 086 749	
19.2790.012.099		399 x 222	500 086 750	
19.2790.031.099		223 x 218	500 086 753	
19.2790.032.099		223 x 218	500 086 754	
11.2790.001.099		640 x 240 x 108	580 249 8968	
11.2790.002.099		640 x 240 x 108	580 249 8969	

S-Way, T-Way



2020

IVECO

MAN

M 90, F 90

03/00



320	II [e1] 02★14054 II [e1] 02★14053 II (E1) 0114053	II		Ø 18-30 mm
	Beschreibung description descripción descrição descripció beniárning popis opis opis		mm	OE
51.3200.147H		380 x 190 x 100	81.63730-6193	
40.3200.422H		366 x 176 x 3	81.63733-0036	
09.3200.420H		42 x 42 x 54 [2000]	88.25505-0024	

MAN

M 90, F 90

08/88 - 09/94



340 341	II [e1] 02★14098 II (E1) 0114098	II		① Ø 14-20 mm ② Ø 20-30 mm
	Beschreibung description descripción descrição descripció beniárning popis opis opis		mm	OE
51.3410.127H		377 x 189 x 65	81.63730-6233 + 81.63730-6220	
51.3412.120H		377 x 189 x 65	81.63730-6420	
40.3640.222H		363 x 175 x 3	81.63733-0025 + 81.63733-0030 81.63733-0060	
51.3410.147H		377 x 189 x 65	81.63730-6234 + 81.63730-6221 81.62730-6221	
51.3410.140		377 x 189 x 65		
40.3640.422H		363 x 175 x 3	81.63733-0064 + 81.63733-6003 81.63730-0032 + 81.63730-6003 81.63730-6202 + 85.20000-9601	
10.6121.100		340 x 159		
09.2000.301H		2000 x 9 Ø	83.25402-6010	
51.3400.147H		377 x 189 x 65	88.63730-6041 + 85.63730-6015 81.63730-6016	
40.3640.422H		363 x 175 x 3	81.63733-0064 + 81.63733-6003 81.63730-0032 + 81.63730-6003 81.63730-6202 + 85.20000-9601	
09.3400.420		42 x 42 x 54 [2000]		

M 90, F 90

07/88



260	IV [e1] 02★11001	IV		Ø 14-20 mm
	Beschreibung description descripción descrição descripció beniárning popis opis opis		mm	OE
56.2600.127H		205 x 158 x 70	81.63730-6206	
40.2605.204H		190 x 143 x 3	81.63733-0042	
56.2600.147H		205 x 158 x 70		
40.2605.204H		190 x 143 x 3	81.63733-0042	
10.6321.100		186 x 130		
09.2070.101H		2070 x 9 Ø	81.25432-0149	

MAN

266 266-1	IV V 02★11008 IV V 0111008 IV V 0211008			① Ø 14-20 mm ② Ø 20-30 mm
----------------------------	--	--	--	------------------------------

		Beschreibung description descripção descripzione benamning popis описание özellik leírás opis		mm		OE	
56.2660.127H	①	214 x 164 x 55	81.63730-6235 + 81.63730-6222				
56.2662.120H	②	214 x 164 x 55	81.63730-6421				
56.2660.147H	①	214 x 164 x 55	81.63730-6236 + 81.63730-6223 81.63730-6299				
40.2660.404H		200 x 150 x 3	81.63733-6007				
10.6321.100		186 x 130					
09.2000.301H		2000 x 9 ø	83.25402-6010				
56.2660.001.099	①	214 x 164 x 60					
56.2660.004.099	①	214 x 164 x 60					
40.2665.203H		200 x 150 x 3					
56.2660.002.099	②	214 x 164 x 60	81.63730-6754				
40.2665.403H		200 x 150 x 3					
10.6321.100		186 x 130					
09.2000.301H		2000 x 9 ø	83.25402-6010				

M 90, F 90



265	V 02★12007 V 0112007			① Ø 10 mm ②
------------	---------------------------	--	--	----------------

		Beschreibung description descripção descripzione benamning popis описание özellik leírás opis		mm		OE	
56.2650.121H	①	247 x 157 x 63	81.63730-6224				
59.2652.110H	②	247 x 157 x 63	81.63730-6237				

M 90, F 90
G 90



365-1	V VI 03★0015 V VI 020922 V VI 02★12015 V VI 0112015			
--------------	--	--	--	--

		Beschreibung description descripção descripzione benamning popis описание özellik leírás opis		mm		OE	
59.3652.128H		324 x 184 x 98	82.63730-6033 + 81.63730-6294				
15.3946.670F		324 x 184 x 61	81.63733-0099				
59.3652.148H		324 x 184 x 98	82.63730-6034				
59.3652.168H		324 x 184 x 85	82.63730-6035				

M 90, F 90
G 90

F 2000, L 2000
M 2000
TG-L, TG-M

08/88 - 09/94
09/87 - 05/95

09/94
09/97
06/05



MAN / VW G 90 (6-9 t) 10/75 - 07/88



MAN

251		II e1 01★14050		Truck II	ABS	Ø 14-20 mm
MEKRA LANG Group		Beschreibung description descripción descricao benämning pops описанье özellik leirás opis		mm		OE
51.2510.127H		318 x 186 x 26	81.63730-6167 + 81.63730-6127			
40.2510.222H		308 x 176 x 3	81.63733-0032			
51.2510.137H		318 x 186 x 26				
40.2510.322H		308 x 176 x 3				
10.6211.100		282 x 162				
09.2070.101H		2070 x 9 ø	81.25432-0149			
51.2510.147H		318 x 186 x 26	81.63730-6128 + 81.63730-6148			
40.2510.422H		308 x 176 x 3				
10.6221.100		282 x 162				
09.2070.101H		2070 x 9 ø	81.25432-0149			

MAN

10/75 - 07/88

F8, F9



364		II e1 02★14082 II e1 0114082		Truck II	ABS	Ø 14-20 mm
MEKRA LANG Group		Beschreibung description descripción descricao benämning pops описанье özellik leirás opis		mm		OE
51.3640.127H		376 x 187 x 28	81.63730-6108 + 81.63730-6126 81.63730-6149 + 81.63730-6147 81.63730-6148 + 81.63730-6194			
40.3640.222H		363 x 175 x 3	81.63733-0025 + 81.63733-0030 81.63733-0060			
51.3640.137H		376 x 187 x 28				
40.3640.322H		363 x 175 x 3				
10.6111.100		340 x 159				
09.2070.101H		2070 x 9 ø	81.25432-0149			
51.3640.147H		376 x 187 x 28	81.63730-6151 + 81.63730-6001			
40.3640.422H		363 x 175 x 3	81.63733-0064 + 81.63733-6003 81.63730-0032 + 81.63730-6003 81.63730-6202 + 85.20000-9601			
10.6121.100		340 x 159				
09.2070.101H		2070 x 9 ø	81.25432-0149			

MAN

572		II 03★0031 II 020918				∅ (18) / 22 / 28 mm
		Beschreibung description descripção descrizione benamning Popis описанье breiðlik leirás opis				OE
51.5720.120H		426 x 200 x 135	85.63730-6030			
40.5725.212H		412 x 188 x 3	81.63733-0101			
51.5720.140H		426 x 200 x 135	85.63730-6033			
40.5725.412H		412 x 188 x 3	81.63733-0103			
51.5721.160H		426 x 200 x 135	85.63730-6035			
51.5722.160H		426 x 200 x 135	85.63730-6036			
40.5725.412H		412 x 188 x 3	81.63733-0103			
61.5721.004.099		78 x 69 x 38				
11.5721.001.099		426 x 199 x 36				
11.3860.700		100 x 22 ∅ → 18 ∅				

06/2005 →
06/2005 →
TGL, TGM (TGA)
L 2000, M 2000



573		IV 03★0032 IV 020917				∅ (18) / 22 / 28 mm
		Beschreibung description descripção descrizione benamning Popis описанье breiðlik leirás opis				OE
56.5730.120H		202 x 198 x 126	85.63730-6037			
40.5735.203H		190 x 184 x 3	81.63733-0104			
56.5730.140H		202 x 198 x 126	85.63730-6039			
40.5735.403H		190 x 184 x 3	81.63733-0106			
61.5721.004.099		78 x 69 x 38				
11.5731.001.099		202 x 198 x 27				
11.3860.700		100 x 22 ∅ → 18 ∅				



579		V 03★0109 V 021179				
		Beschreibung description descripção descrizione benamning Popis описанье breiðlik leirás opis				OE
56.5790.003.099		303 x 163 x 88	81.63730-6734 + 81.63730-6574			
15.5791.570.099		303 x 163 x 55	81.63733-6078			
56.5790.004.099		303 x 163 x 88	81.63730-6733 + 81.63730-6573			
15.5791.470H		303 x 163 x 55	81.63733-6074			



MAN

373

II  02★0524II  010524

ABS

Ø (18) / 22 mm

MEKRA
LANG GroupBeschreibung
description
descripción
descrizione
benámenning
popis
omicaune
özelliik
leirás
opis

OE

51.3735.124H		384 x 205 x 120	81.63730-6315 * 81.63730-6365 81.63730-6361
51.3736.124H		384 x 205 x 120	81.63730-6304 * 81.63730-6366 81.63730-6362 * 81.63732-0046
51.3731.325		384 x 205 x 120	
51.3732.325		384 x 205 x 120	
51.3735.126H		384 x 205 x 120	81.63730-6316 * 81.63730-6367 81.63730-6363 * 81.63732-0051
51.3736.126H		384 x 205 x 120	81.63730-6305 * 81.63730-6368 81.63730-6364 * 81.63732-0047
15.3731.373		369 x 190 x 42	
15.3731.074H		369 x 190 x 42	81.63733-0067 * 81.63733-0075
11.3730.310H		367 x 187 x 60	
11.3860.700		100 x 22 ø -> 18 ø	

386

IV  02★0424IV  010424

ABS

Ø (18) / 22 mm

MEKRA
LANG GroupBeschreibung
description
descripción
descrizione
benámenning
popis
omicaune
özelliik
leirás
opis

OE













56.3860.112H		219 x 170 x 120	81.63730-6306
56.3860.114H		219 x 170 x 120	81.63730-6307 * 81.63732-0050
56.3861.116H		219 x 170 x 120	81.63730-6317 * 81.63732-0049
56.3862.116H		219 x 170 x 120	81.63730-6308 * 81.63730-6328 81.63732-0048
11.3860.300H		203 x 154 x 60	
11.3860.700		100 x 22 ø -> 18 ø	









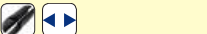

F 2000, L 2000
M 2000

09/94 - 03/00
09/97 - 03/00



MAN

380-1		II  03★0022 II  020905		 II		Ø (18) / 22 mm
		Beschreibung description descripção descrizione benámening Popis оригинале leírás opis				OE
51.3801.148H		384 x 205 x 120	82.63730-6015			
51.3802.148H		384 x 205 x 120	82.63730-6016			
51.3801.168H		384 x 205 x 120	82.63730-6017			
51.3802.168H		384 x 205 x 120	82.63730-6018			
15.3802.840H		368 x 189 x 40	81.63733-0095			
11.3800.300H		374 x 196 x 40	81.63732-0044			
11.3860.700		100 x 22 ø -> 18 ø				

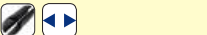
381-1		IV  03★0023 IV  021248		 IV		Ø (18) / 22 mm
		Beschreibung description descripção descrizione benámening Popis оригинале leírás opis				OE
56.3812.128H		219 x 170 x 120	82.63730-6022 + 82.63730-6021			
56.3812.148H		219 x 170 x 120	82.63730-6024 + 82.63730-6023			
56.3811.168H		219 x 170 x 120	82.63730-6025			
56.3812.168H		219 x 170 x 120	82.63730-6026			
11.3810.340		209 x 160 x 40	81.63732-0078 + 81.63732-0045			
11.3860.700		100 x 22 ø -> 18 ø				

New Regulation
F 2000, L 2000
M 2000
2003/97/ECE
2007/38/ECE
09/94 - 03/00
09/97 - 03/00



MAN

F2000
TGA
TGL
TGM09/94 - 03/00
03/00 →
2005 - 11/14
04/06 - 11/14

579	V 03★0109 V 021179			
MEKRA LANG Group	Beschreibung description descripção descripziõe benájmíníng popis opis/cawne üzellik opis		OE	
56.5790.003.099		303 x 163 x 88	81.63730-6734 + 81.63730-6574	
15.5791.570.099		303 x 163 x 55	81.63733-6078	
56.5790.004.099		303 x 163 x 88	81.63730-6733+ 81.63730-6573	
15.5791.470H		303 x 163 x 55	81.63733-6074	

03/00 - 11/06
2005 - 11/06
04/06 - 11/06TGA
TGL
TGM

392	II 02★0646 II 010646			Ø 28 mm
MEKRA LANG Group	Beschreibung description descripção descripziõe benájmíníng popis opis/cawne üzellik opis		OE	
51.3921.222H		399 x 207 x 137	81.63730-6395 + 81.63730-6345 81.63730-6430	
51.3922.222H		399 x 222 x 138	81.63730-6399 + 81.63730-6347 81.63730-6432	
04.0603.007.000		30 x 6 ø		
11.3921.110H		399 x 196 x 52	81.63732-0054 + 81.63732-0059 81.63732-0063	
11.3921.120H		399 x 210 x 52	81.63732-0055 + 81.63732-0060 81.63732-0064	

MAN

392-1	II e1 03★0024 II (E1) 02 0925	 II	ABS	Ø 28 mm
--------------	--	--	------------	---------

MEKRA LANG Group	Beschreibung description descripção descrizione benamning popis описанье özellik leirás opís				mm	OE
	Icon 1	Icon 2	Icon 3	Icon 4		
51.3921.224H					399 x 207 x 137	81.63730-6482
51.3923.224H					339 x 222 x 138	81.63730-6487
51.3921.223H					399 x 207 x 137	81.63730-6480
51.3923.223D					399 x 222 x 138	81.63730-6485
15.3920.840H					379 x 176 x 47	81.63733-6049
51.3922.224H					399 x 222 x 138	81.63730-6483
51.3924.224H					399 x 207 x 137	81.63730-6486
51.3922.223H					399 x 222 x 138	81.63730-6481
51.3924.223D					399 x 207 x 137	81.63730-6484
15.3920.840H					379 x 176 x 47	81.63733-6049
11.3921.400					117 x 62 x 9	81.63731-0309 + 81.63731-0366
04.0603.007.000					30 x 6 ø	
11.3921.110H					399 x 196 x 52	81.63732-0054 + 81.63732-0059 81.63732-0063
11.3921.120H					399 x 210 x 52	81.63732-0055 + 81.63732-0060 81.63732-0064

393-1	IV e1 03★0025 IV (E1) 02 0924	 IV	ABS	Ø 28 mm
--------------	--	--	------------	---------

MEKRA LANG Group	Beschreibung description descripção descrizione benamning popis описанье özellik leirás opís				mm	OE
	Icon 1	Icon 2	Icon 3	Icon 4		
56.3931.343H					188 x 207 x 129	81.63730-6510
56.3931.323H					188 x 207 x 129	81.63730-6512
15.3932.870H					177 x 167 x 38	81.63733-6057
56.3932.343H					188 x 220 x 130	81.63730-6511
56.3932.323H					188 x 220 x 130	81.63730-6513
15.3932.870H					177 x 167 x 38	81.63733-6057
11.3921.400					117 x 62 x 9	81.63731-0309 + 81.63731-0366
04.0603.007.000					30 x 6 ø	
11.3931.110H					187 x 197 x 52	81.63732-0057 + 81.63732-0061 81.63732-0065
11.3931.120H					187 x 209 x 52	81.63732-0056 + 81.63732-0062 81.63732-0066

New Regulation
2003/97/ECE

12/06 →
12/06 - 11/14
12/06 - 11/14

TGA
TGL
TGM



New Regulation
2007/38/ECE

01/07 →
12/06 - 11/14
12/06 - 11/14

TGA
TGL
TGM

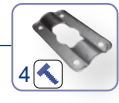

TGL Evolution
TGM Evolution
(Euro 6) 12/14
(Euro 6) 12/14



392-2				II [e1] 03★0024 II (E1) 02 0925	Truck II	ABS	Ø 28 mm
MEKRA LANG Group		Beschreibung description descripção descripziõe benämning popis omicaawe üzellik leirás opis	mm	OE			
51.3920.002.099		399 x 210 x 120	81.63730-6738				
51.3920.004.099		399 x 225 x 121	81.63730-6745				
51.3920.001.099		399 x 210 x 120	81.63730-6739				
51.3920.014.099		399 x 225 x 121	81.63730-6746				
51.3920.003.099		399 x 225 x 121	81.63730-6740				
51.3920.005.099		399 x 210 x 120	81.63730-6743				
51.3920.013.099		399 x 225 x 121	81.63730-6741				
51.3920.012.099		399 x 210 x 120	81.63730-6744				
19.3920.011.099		379 x 176 x 34	81.63733-6079				
12.3920.001.099		399 x 203 x 52	81.63732-0094				
12.3920.002.099		399 x 208 x 53	81.63732-0095				
11.3921.400		117 x 62 x 9	81.63731-0309 + 81.63731-0366				
04.0603.007.000		30 x 6 ø					



393-2				IV [e1] 03★0025 IV (E1) 02 0924	Truck IV	ABS	Ø 28 mm
MEKRA LANG Group		Beschreibung description descripção descripziõe benämning popis omicaawe üzellik leirás opis	mm	OE			
56.3930.004.099		187 x 210 x 127	81.63730-6748				
56.3930.002.099		187 x 210 x 127	81.63730-6749				
56.3930.003.099		188 x 223 x 128	81.63730-6750				
56.3930.001.099		188 x 223 x 128	81.63730-6751				
19.3930.311.099		177 x 167 x 35	81.63733-6080				
12.3930.001.099		187 x 197 x 52	81.63732-0096				
12.3930.002.099		187 x 209 x 52	81.63732-0097				
11.3921.400		117 x 62 x 9	81.63731-0309 + 81.63731-0366				
04.0603.007.000		30 x 6 ø					

TGX / TGS
TGL Evolution
TGM Evolution
01/2011
(Euro 6) 12/14
(Euro 6) 12/14



579				V [e1] 03★0109 V (E1) 021179	Truck V	ABS	
MEKRA LANG Group		Beschreibung description descripção descripziõe benämning popis omicaawe üzellik leirás opis	mm	OE			
56.5790.002.099		303 x 163 x 88	81.63730-6735 + 81.63730-6578				
15.5791.570.099		303 x 163 x 55	81.63733-6078				

MAN

580	II 03★0097			INTEGR.
	II 020929			
	IV 03★0098			
	IV 020930			

	Beschreibung description descripción descrizione description benámenning Pops оmycaвe бeллeк letrās oips	 mm	OE

59.5800.101H		943 x 382 x 153	81.63730-6529	TGX
59.5800.102H		943 x 382 x 153	81.63730-6560 + 81.63730-6756	
59.5800.302H		943 x 382 x 153	81.63730-6563 + 81.63730-6767	
59.5800.201H		943 x 382 x 153	81.63730-6531	
59.5800.202H		943 x 382 x 153	81.63730-6561 + 81.63730-6765	
59.5800.203H		943 x 382 x 153	81.63730-6564 + 81.63730-6770	
59.5800.402H		943 x 382 x 153	81.63730-6562 + 81.63730-6758	

58.5800.101H		943 x 281 x 28 ø	81.63731-6638
58.5800.102H		943 x 281 x 28 ø	81.63731-6639

59.5800.121H		943 x 437 x 153	81.63730-6533	TGS
59.5800.122H		943 x 437 x 153	81.63730-6549 + 81.63730-6755	
59.5800.322H		943 x 437 x 153	81.63730-6552 + 81.63730-6764	
59.5800.221H		943 x 437 x 153	81.63730-6534	
59.5800.222H		943 x 437 x 153	81.63730-6550 + 81.63730-6762	
59.5800.223H		943 x 437 x 153	81.63730-6553 + 81.63730-6761	
59.5800.422H		943 x 437 x 153	81.63730-6551 + 81.63730-6757	

58.5800.201H		943 x 334 x 28 ø	81.63731-6640
58.5800.202H		943 x 334 x 28 ø	81.63731-6641

15.5801.840H		381 x 201 x 22	81.63733-6071
15.5811.871H		197 x 181 x 42	81.63733-6073
15.5811.872H		197 x 181 x 42	81.63733-6072

08.5752.024.099		130 x 94 x 53	81.63734-6001
08.1024.124.099		130 x 120 x 45	81.63734-6006

13.5800.100H		634 x 259 x 90	81.63732-0091
11.5800.100H		631 x 237 x 174	81.63731-0356
11.5800.200H		631 x 237 x 174	81.63731-0380

20.5800.410H		289 x 149 x 85	81.63732-0073
20.5800.420H		289 x 149 x 85	81.63732-0074
20.5800.610H		242 x 140 x 94	81.63732-0075
20.5800.620H		242 x 140 x 94	81.63732-0076
20.5800.710H		127 x 116 x 33	81.62410-0107
20.5800.720H		127 x 116 x 33	81.62410-0108
20.5800.750H		13 x 19 ø	81.63732-0090 + 81.62410-0109

TGX / TGS

09/07 - 2021

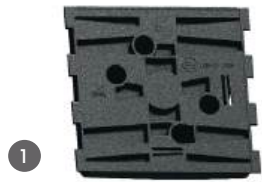

MAN

TGX/TGS new
TGL new
TGM new

2020
2020
2020

MAN

1024	II (E1) 041543 IV (E1) 041542			INTEGR.
	Beschreibung description description description benamning pops omicaime bèitlik lefrás opis			



LHD	59.1024.001.099				kurz short	936 x 355 x 206	81.63730-6859
	59.1024.002.099				kurz short	936 x 355 x 206	81.63730-6860
	59.1024.005.099				lang long	936 x 455 x 288	81.63730-6875
	59.1024.006.099				lang long	936 x 455 x 288	81.63730-6874
	59.1024.009.099				kurz short	936 x 355 x 206	81.63730-6853
	59.1024.010.099				kurz short	936 x 355 x 206	81.63730-6854
	59.1024.013.099				lang long	936 x 455 x 288	81.63730-6869
	59.1024.014.099				lang long	936 x 455 x 288	81.63730-6868
	59.1024.017.099				kurz short	936 x 355 x 206	81.63730-6865
	59.1024.019.099				lang long	936 x 455 x 206	81.63730-6878
RHD	59.1024.022.099				lang long	936 x 455 x 288	81.63730-6879
	59.1024.023.099				kurz short	936 x 355 x 206	81.63730-6861
	59.1024.025.099				lang long	936 x 455 x 288	81.63730-6877
	59.1024.026.099				lang long	936 x 455 x 288	81.63730-6876
	59.1024.027.099				kurz short	936 x 355 x 206	81.63730-6855
	59.1024.028.099				kurz short	936 x 355 x 206	81.63730-6856
	59.1024.029.099				lang long	936 x 455 x 288	81.63730-6871
	59.1024.030.099				lang long	936 x 455 x 288	81.63730-6870
	19.1024.011.099					① 379 x 193 x 35	81.63733-6083
	19.1024.012.099					① 379 x 193 x 35	81.63733-6084
19.1024.311.099					② 204 x 196 x 51	81.63733-6085	
19.1024.312.099					② 204 x 196 x 51	81.63733-6086	
08.5752.024.099					③ 130 x 94 x 53	81.63734-6001	
08.1024.124.099					③ 130 x 120 x 45	81.63734-6006	
13.1024.001.099					④ 427 x 244 x 122	81.63732-0111	
13.1024.002.099					④ 427 x 244 x 122	81.63732-0110	
13.1024.003.099				paintable	⑤ 427 x 244 x 122	81.63732-0125	
13.1024.004.099				paintable	⑤ 427 x 244 x 122	81.63732-0124	
12.1024.009.099				für pour foot cover top	⑥ 241 x 137 x 105	81.63732-0115	
12.1024.010.099				für pour foot cover top	⑥ 241 x 137 x 105	81.63732-0114	
12.1024.011.099				für pour foot cover bottom	⑦ 215 x 148 x 100	81.63732-0113	
12.1024.012.099				für pour foot cover bottom	⑦ 215 x 148 x 100	81.63732-0112	

MAN

1020	V (E1) 041389			INTEGR.
-------------	---------------	--	--	----------------

	Beschreibung description description description benamning pops описание birelik letras opis		OE
--	---	--	-----------

56.1020.017.099				LIN-BUS	307 x 279 x 95	81.63730-6845
56.1020.018.099				LIN-BUS	307 x 279 x 95	81.63730-6846
56.1020.020.099					307 x 279 x 95	81.63730-6843
56.1020.015.099					307 x 279 x 95	81.63730-6881
19.1020.213.099				a	297 x 172 x 62	81.63733-6087
19.1020.613.099				a	297 x 172 x 62	81.63733-6088
12.1020.003.099				b	191 x 137 x 41	81.63732-0106
08.1024.124.099					130 x 120 x 45	81.63734-6006

2018

MAN TGX/TGS

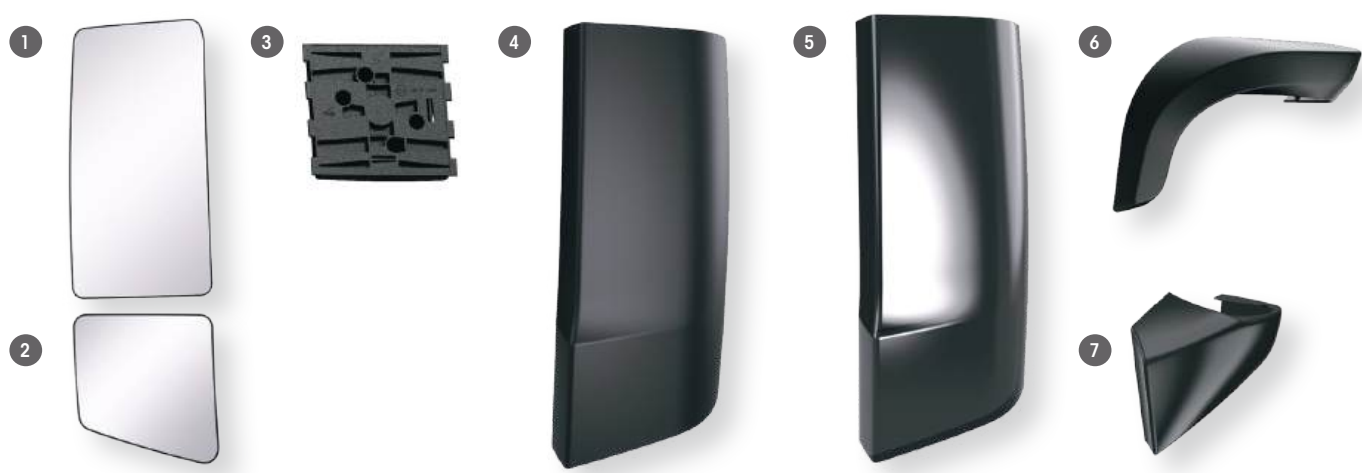

MAN

2017

MAN

TGE

MAN

1013 **NEW** II (E1) 041427 **INTEGR.**

mm



1



2

LHD	Pos.	MEKRA	MAN	Features										Dimensions	Part Numbers	
				FM	LTE	GNSS	12V	BSM	07/24	FM	GNSS	BSM	07/24			
	59.1013.117.299			FM											384 x 330 x 257	7C1857387FJ ♦ 7C1857387GA 1, 5, 12, 14, 16, 18, 22, 24, 25, 27 *
	59.1013.216.299														384 x 309 x 314	7C1857388EG ♦ 7C1857388EM 6, 15, 17, 19, 22, 23, 25, 29 *
	59.1013.109.299			12V											384 x 330 x 257	7C1857387FK ♦ 7C1857387GB 1, 4, 5, 12, 14, 16, 18, 24, 25, 27 *
	59.1013.159.299			12V						BSM	07/24				384 x 330 x 257	7C1857387GC 1, 4, 5, 12, 14, 16, 20, 24, 25, 27 *
	59.1013.201.299			12V											384 x 309 x 314	7C1857388EH ♦ 7C1857388EP 4, 6, 15, 17, 19, 23, 25, 29 *
	59.1013.212.299			12V							GNSS				384 x 309 x 314	7C1857388EC ♦ 7C1857388FC 2, 3, 4, 6, 13, 15, 17, 19, 23, 25, 29 *
	59.1013.251.299			12V						BSM	07/24				384 x 309 x 314	7C1857388EQ 4, 6, 15, 17, 21, 23, 25, 29 *
	59.1013.106.299			12V								FM			384 x 330 x 257	7C1857387FM ♦ 7C1857387GD 1, 4, 5, 12, 14, 16, 18, 24, 25, 26 *
	59.1013.154.299			12V								BSM	07/24		384 x 330 x 257	7C1857387GE 1, 4, 5, 12, 14, 16, 20, 24, 25, 26 *
	59.1013.202.299			12V											384 x 309 x 314	7C1857388EK ♦ 7C1857388ES 4, 6, 15, 17, 19, 23, 25, 28 *
	59.1013.253.299			12V								BSM	07/24		384 x 309 x 314	7C1857388ET 4, 6, 15, 17, 21, 23, 25, 28 *
	59.1013.317.299														384 x 309 x 314	7C2857387CN ♦ 7C2857387DA 1, 10, 12, 14, 16, 18, 22, 24, 25, 31 *
	59.1013.416.299														384 x 330 x 257	7C2857388CB ♦ 7C2857388CE 11, 15, 17, 19, 22, 23, 25, 33 *
	59.1013.309.299			12V								FM			384 x 309 x 314	7C2857387CP ♦ 7C2857387DC 1, 4, 10, 12, 14, 16, 18, 24, 25, 31 *
	59.1013.354.299			12V								BSM	07/24		384 x 309 x 314	7C2857387DE 1, 4, 10, 12, 14, 16, 20, 24, 25, 30 *
	59.1013.401.299			12V											384 x 330 x 257	7C2857388CC ♦ 7C2857388CF 4, 11, 15, 17, 19, 23, 25, 33 *
	59.1013.412.299			12V								GNSS			384 x 330 x 257	7C2857388BT ♦ 7C2857388CJ 2, 3, 4, 11, 13, 15, 17, 19, 23, 25, 33 *
	59.1013.453.299			12V									BSM	07/24	384 x 330 x 257	7C2857388CG 4, 11, 15, 17, 21, 23, 25, 32 *
LHD	59.1013.509.299			12V											384 x 434 x 191	7CB857387BC ♦ 7CB857387BG 4, 5, 7, 12, 14, 16, 18, 24, 25, 34 *
	59.1013.601.299			12V											384 x 434 x 238	7CB857388AL ♦ 7CB857388AR 4, 6, 15, 17, 19, 23, 25, 35 *
	59.1013.612.299			12V									GNSS		384 x 434 x 238	7CB857388AN ♦ 7CB857388BB 4, 6, 8, 9, 13, 15, 17, 19, 23, 25, 35 *
	59.1013.651.299			12V									BSM	07/24	384 x 434 x 238	7CB857388AS 4, 6, 15, 17, 21, 23, 25, 35 *

* Der Komplettspiegel besteht aus den aufgelisteten Positionen.
Die Zuordnung der Artikelnummern erfolgt in der untenstehenden Tabelle.
The complete mirror consists of the items listed.
The assignment of the item numbers is shown in the table below.

Pos.	MEKRA	MAN	FM	LTE	GNSS	12V	BSM	07/24	FM	GNSS	BSM	07/24	Rumpfspiegel - carcass														
1	08.1013.007.000	65.28205-6000											65.63731-6042	65.63731-6041	65.63731-6033	65.63731-6046	65.63731-6034	65.63731-6045	65.63731-6049	65.63731-6037	65.63731-6048	65.63731-6052	65.63731-6038	65.63731-6051	65.63731-6025	65.63731-6056	65.63731-6026
2	08.1013.008.000	65.28205-6001											65.63731-6042	65.63731-6041	65.63731-6033	65.63731-6046	65.63731-6034	65.63731-6045	65.63731-6049	65.63731-6037	65.63731-6048	65.63731-6052	65.63731-6038	65.63731-6051	65.63731-6025	65.63731-6056	65.63731-6026
3	08.1013.009.000	65.28205-6002											65.63731-6042	65.63731-6041	65.63731-6033	65.63731-6046	65.63731-6034	65.63731-6045	65.63731-6049	65.63731-6037	65.63731-6048	65.63731-6052	65.63731-6038	65.63731-6051	65.63731-6025	65.63731-6056	65.63731-6026
4	08.1013.010.099	65.63734-0002											65.63731-6042	65.63731-6041	65.63731-6033	65.63731-6046	65.63731-6034	65.63731-6045	65.63731-6049	65.63731-6037	65.63731-6048	65.63731-6052	65.63731-6038	65.63731-6051	65.63731-6025	65.63731-6056	65.63731-6026
5	08.1013.012.199	65.25320-6001											65.63731-6042	65.63731-6041	65.63731-6033	65.63731-6046	65.63731-6034	65.63731-6045	65.63731-6049	65.63731-6037	65.63731-6048	65.63731-6052	65.63731-6038	65.63731-6051	65.63731-6025	65.63731-6056	65.63731-6026
6	08.1013.013.199	65.25320-6002											65.63731-6042	65.63731-6041	65.63731-6033	65.63731-6046	65.63731-6034	65.63731-6045	65.63731-6049	65.63731-6037	65.63731-6048	65.63731-6052	65.63731-6038	65.63731-6051	65.63731-6025	65.63731-6056	65.63731-6026
7	08.1013.107.000	65.28205-0005											65.63731-6042	65.63731-6041	65.63731-6033	65.63731-6046	65.63731-6034	65.63731-6045	65.63731-6049	65.63731-6037	65.63731-6048	65.63731-6052	65.63731-6038	65.63731-6051	65.63731-6025	65.63731-6056	65.63731-6026
8	08.1013.108.000	65.28205-0006											65.63731-6042	65.63731-6041	65.63731-6033	65.63731-6046	65.63731-6034	65.63731-6045	65.63731-6049	65.63731-6037	65.63731-6048	65.63731-6052	65.63731-6038	65.63731-6051	65.63731-6025	65.63731-6056	65.63731-6026
9	08.1013.109.000	65.28205-0007											65.63731-6042	65.63731-6041	65.63731-6033	65.63731-6046	65.63731-6034	65.63731-6045	65.63731-6049	65.63731-6037	65.63731-6048	65.63731-6052	65.63731-6038	65.63731-6051	65.63731-6025	65.63731-6056	65.63731-6026
10	08.1013.712.199	65.25320-6003											65.63731-6042	65.63731-6041	65.63731-6033	65.63731-6046	65.63731-6034	65.63731-6045	65.63731-6049	65.63731-6037	65.63731-6048	65.63731-6052	65.63731-6038	65.63731-6051	65.63731-6025	65.63731-6056	65.63731-6026
11	08.1013.713.199	65.25320-6004											65.63731-6042	65.63731-6041	65.63731-6033	65.63731-6046	65.63731-6034	65.63731-6045	65.63731-6049	65.63731-6037	65.63731-6048	65.63731-6052	65.63731-6038	65.63731-6051	65.63731-6025	65.63731-6056	65.63731-6026
12	11.1013.015.004	65.28240-0000											65.63731-6042	65.63731-6041	65.63731-6033	65.63731-6046	65.63731-6034	65.63731-6045	65.63731-6049	65.63731-6037	65.63731-6048	65.63731-6052	65.63731-6038	65.63731-6051	65.63731-6025	65.63731-6056	65.63731-6026
13	11.1013.016.004	65.28240-0001											65.63731-6042	65.63731-6041	65.63731-6033	65.63731-6046	65.63731-6034	65.63731-6045	65.63731-6049	65.63731-6037	65.63731-6048	65.63731-6052	65.63731-6038	65.63731-6051	65.63731-6025	65.63731-6056	65.63731-6026
14	13.1013.001.099	65.63732-0002											65.63731-6042	65.63731-6041	65.63731-6033	65.63731-6046	65.63731-6034	65.63731-6045	65.63731-6049	65.63731-6037	65.63731-6048	65.63731-6052	65.63731-6038	65.63731-6051	65.63731-6025	65.63731-6056	65.63731-6026
15	13.1013.002.099	65.63732-0003											65.63731-6042	65.63731-6041	65.63731-6033	65.63731-6046	65.63731-6034	65.63731-6045	65.63731-6049	65.63731-6037	65.63731-6048	65.63731-6052	65.63731-6038	65.63731-6051	65.63731-6025	65.63731-6056	65.63731-6026
16	13.1013.003.099	65.63732-0000											65.63731-6042	65.63731-6041	65.63731-6033	65.63731-6046	65.63731-6034	65.63731-6045	65.63731-6049	65.63731-6037	65.63731-6048	65.63731-6052	65.63731-6038	65.63731-6051	65.63731-6025	65.63731-6056	65.63731-6026
17	13.1013.004.099	65.63732-0001											65.63731-6042	65.63731-6041	65.63731-6033	65.63731-6046	65.63731-6034	65.63731-6045	65.63731-6049	65.63731-6037	65.63731-6048	65.63731-6052	65.63731-6038	65.63731-6051	65.63731-6025	65.63731-6056	65.63731-6026
18	19.1013.011.099	65.63733-0023											65.63731-6042	65.63731-6041	65.63731-6033	65.63731-6046	65.63731-6034	65.63731-6045	65.63731-6049	65.63731-6037	65.63731-6048	65.63731-6052	65.63731-6038	65.63731-6051	65.63731-6025	65.63731-6056	65.63731-6026
19	19.1013.012.099	65.63733-0026											65.63731-6042	65.63731-6041	65.63731-6033	65.63731-6046	65.63731-6034	65.63731-6045	65.63731-6049	65.63731-6037	65.63731-6048	65.63731-6052					

MAN

2017

1013	NEW	II (E1) 041427			INTEGR.
-------------	------------	----------------	--	--	---------

		Beschreibung description descripção descripziune descripçion benamining popis omicaune bërellik leirats opis					OE
61.1013.166.099		12V	380 x 315 x 190	65.63731-6041	❖ 65.63731-6033	1	LHD
61.1013.266.099		12V	380 x 330 x 200	65.63731-6034	❖ 65.63731-6045		
61.1013.153.099		12V	380 x 315 x 190	65.63731-6042		RHD	
61.1013.253.099		12V	380 x 330 x 200	65.63731-6046			
61.1013.366.099		12V	380 x 315 x 190	65.63731-6037	❖ 65.63731-6048	2	LHD
61.1013.466.099		12V	380 x 330 x 200	65.63731-6038	❖ 65.63731-6051		
61.1013.501.099		12V	410 x 380 x 180	65.63731-6025			
61.1013.651.099		12V	410 x 380 x 190	65.63731-6056	❖ 65.63731-6026		

TGE



1013	NEW				
-------------	------------	--	--	--	--

		Beschreibung description descripção descripziune descripçion benamining popis omicaune bërellik leirats opis					OE
19.1013.011.099		120V	211 x 169 x 19	65.63733-0013	❖ 65.63733-0015	1	LHD
19.1013.012.099		120V	211 x 169 x 19	65.63733-0022	❖ 65.63733-0023		
19.1013.813.099		120V	211 x 169 x 19	65.63733-0012	❖ 65.63733-0014		
19.1013.814.099		120V	211 x 169 x 19	65.63733-0024	❖ 65.63733-0026	2	RHD
19.1013.813.099		120V	211 x 169 x 19	65.63733-0020			
19.1013.814.099		120V	211 x 169 x 19	65.63733-0021			
61.1013.003.099		300	319 x 228 x 81	65.63732-6000		3	LHD
61.1013.002.099		300	319 x 228 x 81	65.63732-6001			
13.1013.001.099		für für pour	269 x 178 x 114	65.63732-0002		4	RHD
13.1013.002.099		für für pour	269 x 178 x 114	65.63732-0003			
13.1013.003.099		für für pour	269 x 112 x 114	65.63732-0000		5	LHD
13.1013.004.099		für für pour	269 x 112 x 114	65.63732-0001			
08.1013.012.199			185 x 100 x 87	65.25320-0000	❖ 65.25320-6001	6	RHD
08.1013.013.199			185 x 100 x 87	65.25320-0001	❖ 65.25320-6002		
08.1013.712.199			185 x 100 x 87	65.25320-0002	❖ 65.25320-6003	6	LHD
08.1013.713.199			185 x 100 x 87	65.25320-0003	❖ 65.25320-6004		
08.1013.010.099		12V	94 x 94 x 38	65.63734-0002		7	RHD
61.1013.001.099			94 x 94 x 38	65.63734-0000			
61.1013.005.099			94 x 94 x 38	65.63731-6008		9	



MAN

2002
2002
09/2012

*Euroliner
Trendliner
PLAXTON: Elite*



276	II 02★0524	II 02★ 0423			
	II 010524	II 010423			
	II 03★0022	II 03★0088			
	II 020905	II 020923			

	Beschreibung description descripción descrizione descripcion benamning pops omicaame üzeylik opis		mm	

1	59.2762.101		592 x 205 x 120	
	51.3732.326		384 x 205 x 116	81.63730-6374 + 81.63730-6390
	15.3731.470H		369 x 190 x 42	81.63733-6029 + 81.63733-0075
	11.3730.210H		367 x 187 x 60	81.63732-0058
2	59.2762.322		592 x 205 x 120	
	51.3732.326		384 x 205 x 116	81.63730-6374 + 81.63730-6390
	15.3731.470H		369 x 190 x 42	81.63733-6029 + 81.63733-0075
	11.3730.210H		367 x 187 x 60	81.63732-0058
	59.2762.422		592 x 205 x 120	
	51.3731.326		384 x 205 x 116	81.63730-6375
	15.3731.470H		369 x 190 x 42	81.63733-6029 + 81.63733-0075
	11.3730.210H		367 x 187 x 60	81.63732-0058
	20.2710.620		124 x 59 x 21 [500]	36.63731-6000

09/99
09/01
2002
2003

*Intercity Mega S 2000
R07/08, A 20
Euroliner
Tourliner
Lions Coach Fortuna*



271	II 02★0524				
	II 010524				

	Beschreibung description descripción descrizione descripcion benamning pops omicaame üzeylik opis		mm	

1	59.2712.111		783 x 703 x 212	83.63700-6502 + 81.63700-6091
	51.3731.326		384 x 205 x 116	81.63730-6375
	15.3731.470H		369 x 190 x 42	81.63733-6029 + 81.63733-0075
	15.2711.114		165 x 93 x 25	81.63733-6027
	11.3730.210H		367 x 187 x 60	81.63732-0058
	20.2700.200H		126 x 25 ø	
	20.2710.200H		183 x 181 x 84	81.63731-0289
	20.2480.216H		108 x 50 x 15 [2000]	83.63731-6507
2	59.2712.114		641 x 701 x 200	83.63700-6501 + 81.63700-6092
	51.3732.326		384 x 205 x 116	81.63730-6374 + 81.63730-6390
	15.3731.470H		369 x 190 x 42	81.63733-6029 + 81.63733-0075
	15.2711.114		165 x 93 x 25	81.63733-6027
	15.2712.114		152 x 128 x 23	81.63733-6028
	11.3730.210H		367 x 187 x 60	81.63732-0058
	20.2700.200H		126 x 25 ø	
	20.2710.200H		183 x 181 x 84	81.63731-0289
20.2480.217H		108 x 50 x 15 [5000]	81.63731-6470	

MAN

278		II 03★0128 II 020951 IV 03★0129 IV 020952			
MEKRA LANG Group		Beschreibung description descripção descripziore benamning popis opis opis opis	mm		OE
59.2780.120.099		684 x 247 x 174	88.63700-6059	1	
59.2781.120		684 x 247 x 174			
59.2780.200.001		684 x 247 x 174			
59.2780.140.001		684 x 247 x 174	83.63700-6510	2	
59.2780.150.001		684 x 247 x 174	83.63700-6511		
59.2780.180.001		684 x 247 x 174			
59.2780.170.001		684 x 247 x 174			
20.2710.620		124 x 59 x 21 [500]			
20.2710.650		124 x 59 x 21 [3500]			
08.3200.233H		42 x 42 x 54	81.25525-0232		
15.2780.840		307 x 177 x 22	81.63733-0113		
15.2780.841F		307 x 177 x 22			
15.2780.870		177 x 177 x 34	81.63733-0112		
15.2780.871F		177 x 177 x 34			
11.2780.910		681 x 229 x 104	81.63732-0088		
11.2780.920		681 x 229 x 104	36.63732-0006		
08.5752.012		130 x 120 x 53			
08.5752.024.099		130 x 120 x 53			

MAN Lion's City
 MAN Lion's Regio
 MAN Lion's Star
 Inter Deck, IRISBUS (Citelis),
 KRAVTEX, LAZ, SOLARIS (Urbino),
 VDL (Citea), VOLVO 7900H,
 Heuliez, Caetano, Plaxton, Scania
 2007 →



1



2

MAN

MAN

277

II E1 03★0084

II E1 020915



ABS

INTEGR.

MEKRA
LANG GroupBeschreibung
description
descripção
descripção
benämning
pops
omrcauwe
bœrellik
opis

OE

59.2770.210.099		1001 x 720 x 254	88.63700-6062
59.2770.211.099		1001 x 720 x 254	88.63700-6066
59.2771.210.099		1001 x 720 x 254	88.63700-6060
59.2770.310.099		1001 x 720 x 254	2227 4292 (Volvo) 272 3896 (Scania)
09.2770.210	(→ 59.2770.210.099)	6050 x 6 ø	88.25426-6837
09.2770.211 + 09.2770.210	(→ 59.2770.211.099)	6050 x 6 ø	33.25404-6190 + 88.25426-6837
09.2770.001.000	(→ 59.2771.210.099)	6050 x 6 ø	
08.2910.001.002	LED		33.25203-6001
09.2910.003.099	(for LED)	6050 x 6 ø	
08.3200.233H		42 x 42 x 54	81.25525-0232
08.2770.001.000		45 x 40 x 44	81.25505-6247
08.3950.001.099	Control Unit (→ 59.2771.210.099)	40 x 30 x 30	
15.2771.840		307 x 183 x 23	81.63733-0110
15.2771.870		206 x 166 x 37	81.63733-0111
61.2770.210		670 x 280 x 253	81.63730-0083
61.2772.211.099		670 x 280 x 253	
61.2770.211	(→ 59.2770.210.099 + 59.2770.211.099)	817 x 192 x 130	81.63731-0373
11.2770.920		669 x 254 x 237	81.63732-0087
11.2770.102	für für pour	707 x 123 x 185	36.63732-0000
11.2770.202	für für pour	399 x 149 x 129	36.63732-0002
11.2770.302	für für pour	268 x 151 x 118	36.63732-0001
11.2770.402	für für pour	399 x 153 x 128	36.63732-0003
61.2772.100	für für pour (for LED)	399 x 172 x 129	81.63732-0089
08.5752.024.099		130 x 120 x 53	81.63734-6001
61.2770.900.099	KIT 1		36.63732-6000
61.2770.901.099	KIT 2		

2007 →
MAN Lion's City
MAN Lion's Regio
MAN Lion's Star
IRISBUS (Citelis), KRAVTEX, LAZ,
SOLARIS (Urbino),
VDL (Citea), VOLVO 7900H,
Heuliez, Caetano, Plaxton, Scania

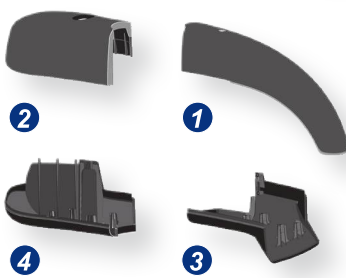

KIT 1

Schamierdeckel
Hinge coverScharnierklemme
Hinge clampSchenkeifeder
Spring screw

KIT 2

Spannschlüssel
WrenchSpannhebel
Bolt leverDruckfeder
Compression spring

MAN

1041		II (E1) 041480		Truck II	ASA	INTEGR.
MEKRA LANG Group		Beschreibung description descripção descripziōna descripziōn benamining popis onivcaune būeilik leirás opis		mm		OE
59.1041.001.099		636 x 907 x 250	36.63700-6018			
59.1041.002.099		636 x 907 x 250	33.63700-6004			
59.1041.004.001		5 636 x 907 x 250				
15.2780.840		a 178 x 307 x 22	36.63733-0011			
19.2910.002.099		b 172 x 184 x 39	36.63733-0012			
12.1041.001.099		274 x 643 x 165	36.63732-0037			
12.1041.002.099		114 x 313 x 63	36.63732-0035			
12.1041.003.099		112 x 194 x 91	36.63732-0034			
12.1041.004.099		113 x 349 x 75	36.63732-0033			
12.1041.005.099		90 x 470 x 118	36.63732-0036			
08.1024.124.099		a 120 x 130 x 45 mm	81.63734-6006 3139595 (Scania)			
09.1041.002.099		a 2400	36.25404-6033			
09.1041.004.099		b 2400	33.28104-6355			

2019 →
Stadtbusse MAN
(Lion's City)



5 Unter 2 m verbaubar und abklappbar
Can be installed and folded away below 2 meters



2019 →

MAN

1042		II (E1) 041481 IV (E1) 041482		Truck II + IV	ASA	INTEGR.
MEKRA LANG Group		Beschreibung description descripção descripziōna descripziōn benamining popis onivcaune būeilik leirás opis		mm		OE
59.1042.001.099		685 x 176 x 237	36.63700-6017	1		
59.1042.005.099		685 x 176 x 237	33.63700-6003			
59.1042.003.099		685 x 176 x 237	36.63700-6019	2		
15.2780.840		a 178 x 307 x 22	36.63733-0011			
19.2910.001.099		b 154 x 183 x 31	36.63733-0010			
12.1042.001.099		232 x 528 x 87	36.63732-0040			
61.1042.005.099		127 x 172 x 111				
61.1042.006.099		167 x 160 x 163				
08.1024.124.099		a 120 x 130 x 45 mm	81.63734-6006 3139595 (Scania)			
20.1042.002.099		2100	36.63731-6012			
20.1042.003.099		2500	36.63731-6013			
09.1041.004.099		b 2400	33.28104-6355			

2019 →
Stadtbusse MAN
(Lion's City)



MERCEDES

253	II 02★14067 II 0114067			Ø 18 mm
------------	-----------------------------	--	--	---------

	Beschreibung description description description benamning popis omircaune üzeylik leirats opis		OE
--	--	--	----

51.2530.120H		370 x 182 x 64	381 810 25 16 + 000 810 27 16 281 810 71 16 + 000 810 62 16 000 811 12 33 + 314 810 26 16 381 810 71 16 + 663 810 08 16 673 810 08 16 + 673 810 40 16 000 811 33 33 + 001 811 87 33 000 811 20 33 + 000 811 64 33 000 811 21 33
40.2530.222H		356 x 170 x 3	000 811 33 33 + 001 811 87 33 000 811 21 33
61.2530.110H		55 x 43 x 36	000 811 02 39
51.2530.140H		370 x 182 x 64	381 810 73 16 + 381 810 26 16 000 810 23 16 + 301 810 21 16 314 810 26 16 + 673 810 42 16
40.2530.422H		356 x 170 x 3	
09.2070.101H		2070 x 9 ø	000 150 55 33
61.2530.110H		55 x 43 x 36	000 811 02 39

1013 - 2644
EvoBus D 303, 404, 405, 407
08/73 - 12/86



MERCEDES

254	II 01★14068			Ø 18 mm
------------	--------------	--	--	---------

	Beschreibung description description description benamning popis omircaune üzeylik leirats opis		OE
--	--	--	----

51.2540.120H		305 x 183 x 60	314 810 13 16 + 000 810 04 16 000 810 48 16 + 673 810 39 16 000 811 35 33 + 001 811 90 33 000 811 19 33
40.2540.222H		291 x 170 x 3	000 811 35 33 + 001 811 90 33 000 811 19 33
61.2530.110H		55 x 43 x 36	000 811 02 39
51.2540.130H		305 x 183 x 60	314 810 19 16 + 000 810 06 16 000 810 20 16
40.2540.222H		291 x 170 x 3	000 811 35 33 + 001 811 90 33 000 811 19 33
09.2070.101H		2070 x 9 ø	000 150 55 33
61.2530.110H		55 x 43 x 36	000 811 02 39
51.2540.140H		305 x 183 x 60	314 810 20 16 + 673 810 41 16
40.2540.422H		291 x 170 x 3	001 811 90 33 + 000 821 08 29
09.2070.101H		2070 x 9 ø	000 150 55 33
61.2530.110H		55 x 43 x 36	000 811 02 39

11/77
12/98

LK08 - 1113
LN2 (LK)



MERCEDES

375	II 03★0123 II 020941 II 02★0505 II 010505		Ø 28 mm
	Beschreibung description descripción descrizione description benámenning popis onircaawne breiðlik leirfás opis		OE
61.3752.147H		380 x 170 x 68	000 810 02 79
15.3752.470H		380 x 170 x 15	001 811 34 33 + 001 811 73 33
61.3780.100H		74 x 65 x 14	000 811 13 07
61.3752.167H		380 x 170 x 68	000 810 03 79
15.3752.470H		380 x 170 x 15	001 811 34 33 + 001 811 73 33
61.3780.100H		74 x 65 x 14	000 811 13 07

*Atego (LKN)
Axor
Unimog U 20*



377 377-1	IV 02★0462 IV 010462 IV 03★0019		Ø 28 mm
	Beschreibung description descripción descrizione description benámenning popis onircaawne breiðlik leirfás opis		OE
61.3770.147H		200 x 200 x 155	000 810 96 16 + 001 811 21 33 + 000 811 13 07
15.3774.410H		200 x 200 x 15	001 811 21 33
61.3772.147H		200 x 200 x 118	000 810 96 16
61.3780.100H		74 x 65 x 14	000 811 13 07
61.3773.147H		200 x 200 x 155	001 810 92 16 + 000 811 13 07
15.3771.174H		200 x 200 x 15	001 811 60 33
61.3780.100H		74 x 65 x 14	000 811 13 07



MERCEDES

*Atego (LKN)
Axor*

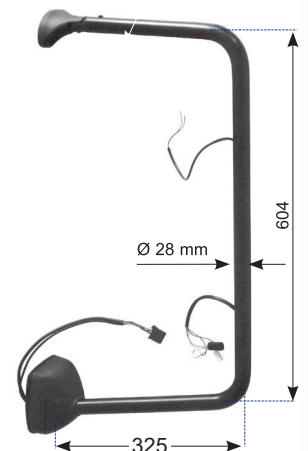

375 A			Ø 28 mm
	Beschreibung description descripción descrizione description benámenning popis onircaawne breiðlik leirfás opis		OE
58.3752.100		639 x 325 x 28 ø	973 810 03 14
58.3752.200		639 x 325 x 28 ø	973 810 04 14
20.3750.710.099		136 x 82 x 73	000 811 03 61
20.3750.720.099		136 x 82 x 73	000 811 04 61

MERCEDES

Atego II (LKN)
Axor II



10/04
10/04

575	II (E1) 021144		ABS	Ø 28 mm
MEKRA LANG Group		mm		OE
Beschreibung description descripção descripzione benamning popis оригинале üzellik leirás opis				
51.5750.003.099		439 x 219 x 124	000 810 17 79 ÷ 000 810 22 79	
51.5750.004.099		439 x 219 x 124	000 810 14 79 ÷ 000 810 23 79	
09.5750.220.099		250	000 820 28 13	
51.5750.001.099		439 x 219 x 124	000 810 18 79 ÷ 000 810 20 79	
51.5750.002.099		439 x 219 x 124	000 810 15 79 ÷ 000 810 21 79	
09.5750.001.099		335	000 820 27 13	
19.5750.011.099		435 x 196 x 39	002 811 46 33	
15.5750.840H		431 x 186 x 15	001 811 99 33	
61.5750.100H		86 x 79 x 77	000 811 20 07	

MERCEDES



577	IV (E1) 021145		ABS	Ø 28 mm
MEKRA LANG Group		mm		OE
Beschreibung description descripção descripzione benamning popis оригинале üzellik leirás opis				
51.5770.001.099		214 x 199 x 116	000 810 16 79 ÷ 000 810 24 79	
19.5770.311.099		203 x 200 x 43	002 811 47 33	
15.5770.870H		192 x 186 x 15	002 811 00 33	
09.5750.220.099		250	000 820 28 13	
61.5750.100H		86 x 79 x 77	000 811 20 07	

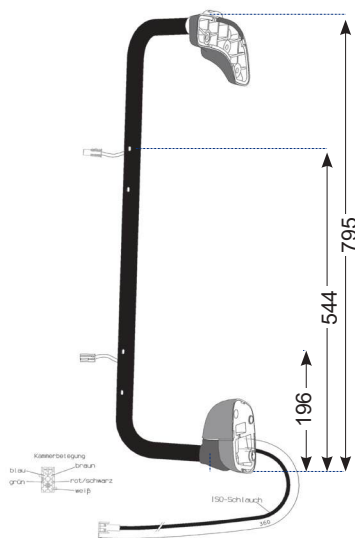

575 A			Ø 28 mm	
MEKRA LANG Group		mm		OE
Beschreibung description descripção descripzione benamning popis оригинале üzellik leirás opis				
58.5752.100H		795 x 321 x 28 ø	001 810 97 14	
58.5752.200H		795 x 376 x 28 ø	001 810 98 14	
58.5750.012.199		795 x 322 x 28 ø	002 810 85 14	
58.5750.005.199		795 x 322 x 28 ø	002 810 94 14	
20.5750.710.099		134 x 80 x 74	000 811 18 07	
20.5750.720.099		134 x 80 x 74	000 811 19 07	

MERCEDES

579	V 03★0109 V 021179		
	Beschreibung description descripção descripziune benájmíníng popis opisacune őzellék leírás opis		OE
56.5790.004.099		303 x 163 x 88	002 810 08 16
15.5791.470H		303 x 163 x 55	002 811 22 33

1004	V 04 1341		
	Beschreibung description descripção descripziune benájmíníng popis opisacune őzellék leírás opis		OE
56.1004.001.099		338 x 275 x 105	002 810 60 16

396	VI 03★0017		INTEGR.
	Beschreibung description descripção descripziune benájmíníng popis opisacune őzellék leírás opis		OE
59.3964.210H		1145 x 265	940 810 55 16
56.3960.148H		130 x 250 ø	000 810 08 79 + 001 811 69 33 + 000 811 13 07
15.3961.174H		45 x 250 ø	001 811 69 33
61.3780.100H		74 x 65 x 14	000 811 13 07

*Atego (LKN)
Axor
Atego II (LKN)
Axor II*

*01/98 - 05/08
09/01 - 09/04
10/04 →
10/04 →*



New Regulation ECE R46/04



MERCEDES



Atego II
Axor II

MERCEDES

378 378-1	II [E1] 02★0463 II [E1] 010463 II [E1] 03★0018			Ø 28 mm
----------------------------	--	--	--	---------

MEKRA LANG Group	Beschreibung description descripção descrizione benamning pops õnivaame õzellig õpits				mm	OE
	1800	24V				
15.3784.470H					433 x 188 x 15	001 811 20 33
61.3782.147H					433 x 188 x 68	000 810 95 16
61.3780.100H					74 x 65 x 14	000 811 13 07
61.3783.147H					433 x 188 x 68	001 810 90 16 + 000 811 13 07
15.3780.840H					433 x 188 x 15	002 811 04 33
61.3780.100H					74 x 65 x 14	000 811 13 07
61.3782.167H					433 x 188 x 68	000 810 94 16
15.3784.470H					433 x 188 x 15	001 811 20 33
61.3780.100H					74 x 65 x 14	000 811 13 07
61.3783.167H					433 x 188 x 68	001 810 91 16 + 000 811 13 07
15.3780.840H					433 x 188 x 15	002 811 04 33
61.3780.100H					74 x 65 x 14	000 811 13 07

Actros (SKL) I+II
Econic

09/96
03/98



377 377-1	IV [E1] 02★0462 IV [E1] 010462 IV [E1] 03★0019			Ø 28 mm
----------------------------	--	--	--	---------

MEKRA LANG Group	Beschreibung description descripção descrizione benamning pops õnivaame õzellig õpits				mm	OE
	400	24V				
61.3770.147H					200 x 200 x 155	000 810 96 16 + 001 811 21 33 + 000 811 13 07
15.3774.410H					200 x 200 x 15	001 811 21 33
61.3772.147H					200 x 200 x 118	000 810 96 16
61.3780.100H					74 x 65 x 14	000 811 13 07
61.3773.147H					200 x 200 x 155	001 810 92 16 + 000 811 13 07
15.3771.174H					200 x 200 x 15	001 811 60 33
61.3780.100H					74 x 65 x 14	000 811 13 07

Actros (SKL) I+II
Econic

09/96 - 05/08
03/98

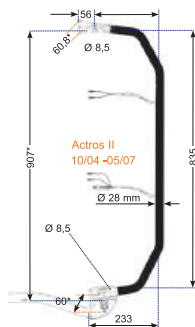

378 A			Ø 28 mm
--------------	--	--	---------

MEKRA LANG Group	Beschreibung description descripção descrizione benamning pops õnivaame õzellig õpits				mm	OE
58.3783.300H					983 x 227 x 28	002 810 08 14
58.3783.200H					983 x 227 x 28	002 810 09 14
20.3780.700H					96 x 91 x 88	941 811 00 07

MERCEDES

579	V e1 03★0109			
	V (E1) 021179			
	Beschreibung description descripção descripzione benamining popis описување özellik opis			OE
56.5790.004.099		303 x 163 x 88	002 810 08 16	
15.5791.470H		303 x 163 x 55	002 811 22 33	

Actros (SKL) I+II
Econic
09/96 - 05/08
03/98 →



1004	V (E1) 04 1341			
	Beschreibung description descripção descripzione benamining popis описување özellik opis			OE
56.1004.001.099		338 x 275 x 105	002 810 60 16	

New Regulation ECE R46/04



396	V e1 03★0017			INTEGR.
	Beschreibung description descripção descripzione benamining popis описување özellik opis			OE
59.3965.210H		1219 x 303	943 810 47 16	
56.3960.148H		130 x 250 ø	000 810 08 79 + 001 811 69 33 + 000 811 13 07	
15.3961.174H		45 x 250 ø	001 811 69 33	
61.3780.100H		74 x 65 x 14	000 811 13 07	

Actros I + II



MERCEDES

ACTROS MP3



1012			
	Beschreibung description descripção descripziune descripziune benämning popis opis opis		
19.1012.002.099		a	401 x 200 x 55 002 811 33 33
19.1012.003.099		a	401 x 200 x 55 002 811 34 33
19.1012.000.099		b	196 x 193 x 44 002 811 37 33
19.1012.001.099		b	196 x 193 x 44 002 811 38 33

10/2011
07/2012
05/2013

ACTROS MP4
ANTOS
AROCS
(SFTP)



600	II (E1) 02★1112 IV (E1) 02★1113			INTEGR.
	Beschreibung description descripção descripziune descripziune benämning popis opis opis			
15.6000.001.099		a	430 x 193 x 34 002 811 63 33	
15.6000.002.099		a	430 x 193 x 34 002 811 64 33	
15.6000.003.099		b	204 x 236 x 51 002 811 65 33	
15.6000.004.099		b	204 x 236 x 51 002 811 66 33	

Komplettsystem (MP3 + MP4) bei Mercedes erhältlich
complete system (MP3 + MP4) available at Mercedes

ACTROS MP3
ACTROS MP4
ANTOS
AROCS
(SFTP)



1004	V (E1) 04 1341			
	Beschreibung description descripção descripziune descripziune benämning popis opis opis			
56.1004.001.099		338 x 275 x 105	002 810 60 16	

New Regulation ECE R46/04

INNOVATIVE INTERDISCIPLINARY



**HIGH
PRODUCTION**
UP TO 70%
VERTICAL INTEGRATION

MERCEDES

1994 →
EvoBus Kombibus
Ares (Renault, Karosa, Iveco)



281	II [E1] 02★0447	Truck II	ABS	INTEGR.
	II (E) 010447			
	II [E1] 02★0448			
MEKRA LANG Group		mm		OE
59.2810.111H		470 x 230 x 85		
59.2810.113H		470 x 230 x 85		
15.2810.480H		409 x 168 x 6		
11.2810.200H		460 x 180 x 50		

1999 →
Conecto C/Ü
Intouro



398	II [E1] 03★0123	Truck II	ABS	OE
	II (E) 020941			
	II [E1] 02★0505			
	II (E) 010505			
MEKRA LANG Group		mm		OE
1	59.3980.021H		551 x 278 x 147	671 810 09 16
	59.3980.022H		551 x 1278 x 47	671 810 13 16
2	59.3980.122		435 x 246 x 143	628 810 31 16
3	59.3980.011H		474 x 733 x 166	671 810 07 16
	59.3980.012		474 x 733 x 166	671 810 12 16
	59.3980.111		474 x 733 x 166	628 810 33 16
4	59.3980.132		622 x 758 x 224	628 810 37 16
	59.3980.141		622 x 758 x 224	633 810 01 16
	59.3980.142		622 x 758 x 224	633 810 02 16
	61.3752.147H		380 x 170 x 68	000 810 02 79
	61.3752.167H		380 x 170 x 68	000 810 03 79
	15.3752.470H		380 x 170 x 15	001 811 34 33 + 001 811 73 33
	61.3773.147H		200 x 200 x 155	001 810 92 16
	15.3771.174H		200 x 200 x 15	001 811 60 33
	61.3780.100H		74 x 65 x 14	000 811 13 07
	20.2480.216H		108 x 50 x 15 [2000]	
	20.2480.217H		108 x 50 x 15 [5000]	

09/97 →
10/03 →
09/99 →
09/97 →
Travego
Tourino
Setra TC 400
Multegeo
Tourismo



395	II [E1] 02★0620	II (E) 020926	II + V	OE
	II (E) 010620	V [E1] 03★0174		
	II [E1] 03★0047	V (E) 020998		
MEKRA LANG Group		mm		OE
	19.3953.174.099		a	368 x 174 x 15 A0458110133
	15.3951.114		b	202 x 153 x 15 629 811 01 33

MERCEDES

249 K	III e1 01★17023		PP	① Ø 10 mm ② Ø 12 mm
Beschreibung description descripção descripziune descripziôn benamining popis ovivcauwe bùeillik leirás opis				OE
51.2491.121H		①	210 x 140 x 21	460 810 01 16 + 601 810 02 16 460 810 03 16
51.2491.122H		②	210 x 140 x 21	601 810 01 16

249 L	II e1 02★14035 II (E1) 0114035		PP	① Ø 10 mm ② Ø 14 - 20 mm
Beschreibung description descripção descripziune descripziôn benamining popis ovivcauwe bùeillik leirás opis				OE
51.2493.121H		①	247 x 157 x 61	612 810 01 66 + 611 810 01 16
51.2493.127H		②	247 x 157 x 61	

349 349 TW	II e1 02★0384 II (E1) 010384 II e1 02★0418 II (E1) 010418		ABS	① INTEGR. ③ Ø 18 mm
Beschreibung description descripção descripziune descripziôn benamining popis ovivcauwe bùeillik leirás opis				OE
51.3490.110H		①	283 x 295 x 80	901 810 01 16 + 901 810 55 16
15.3491.071H			238 x 142 x 6	001 811 06 33
51.3490.120H		②	283 x 340 x 80	901 810 02 16 + 901 810 64 16
15.3491.072H			238 x 142 x 6	001 811 07 33
15.3491.371H		③	238 x 142 x 6	001 811 05 33
15.3491.372H			238 x 142 x 6	001 811 04 33
56.3491.110H		④	175 x 116 x 70	901 810 10 93 + B 66 5603 97
15.2711.214H			165 x 93 x 15	
56.3492.110H		⑤	175 x 116 x 70	901 810 11 93 + B 66 5603 98
15.2711.214H			165 x 93 x 15	
59.3491.110H		⑥	283 x 495 x 80	901 810 25 16 + 901 810 58 16
59.3492.110H			283 x 465 x 80	901 810 37 16 + 901 810 61 16
15.3491.071H			238 x 142 x 6	001 811 06 33
59.3491.120H		⑦	283 x 535 x 80	901 810 26 16 + 901 810 67 16
59.3492.120H			283 x 535 x 80	901 810 38 16 + 901 810 70 16
15.3491.072H			238 x 142 x 6	001 811 07 33

05/77 - 07/81
05/79 →
Transporter
207D - 308 (T1, TN)
Typ 230 GE, 280 GE
Typ 240 GD, 300 GD



08/81 - 02/95
Transporter
207D - 410 (T1, TN)



01/95 - 09/95
Sprinter (T1N)

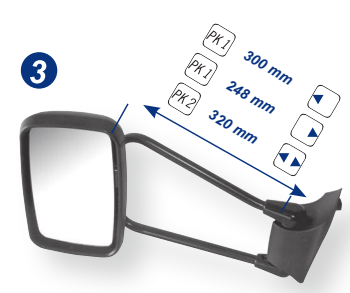

MERCEDES

MERCEDES

589

II III e1 03★0006

II III E1 020902



INTEGR.



Beschreibung
description
description
description
benámenění
pops
omrčavne
čísliclik
reirās
oips



Mercedes Sprinter II
(NCV3)
10/2005 - 11/2017



R H D	L H D	51.5891.111.199		344 x 315 x 182	906 810 48 16 + 906 810 18 93
		51.5891.112.199 *		344 x 315 x 182	906 810 30 93
		51.5891.113.199		344 x 315 x 182	906 810 60 16
		51.5891.114.199 *		344 x 315 x 182	906 810 42 93
		51.5894.112.199 *		344 x 315 x 182	906 810 65 93
		51.5891.311.199		344 x 345 x 182	906 810 51 16 + 906 810 21 93
		51.5894.310.199		344 x 345 x 182	906 810 64 93
		51.5891.312.199 *		344 x 345 x 182	906 810 33 93
		51.5891.313.199		344 x 345 x 182	906 810 63 16
	51.5891.314.199 *		344 x 345 x 182	906 810 45 93	

R H D	L H D	51.5891.211.199		344 x 345 x 182	906 810 49 16 + 906 810 19 93
		51.5891.212.199 *		344 x 345 x 182	906 810 31 93
		51.5891.213.199		344 x 345 x 182	906 810 61 16
		51.5891.214.199 *		344 x 345 x 182	906 810 43 93
		51.5894.212.199 *		344 x 345 x 182	906 810 66 93
		51.5894.410.199		344 x 315 x 182	906 810 63 93
		51.5891.412.199 *		344 x 315 x 182	906 810 32 93
		51.5891.413.199		344 x 315 x 182	906 810 62 16
		51.5891.414.199 *		344 x 315 x 182	906 810 44 93



R H D	L H D	51.5892.111.199		344 x 509 x 182	906 810 52 16 + 906 810 22 93
		51.5892.112.199 *		344 x 509 x 182	906 810 34 93
		51.5892.113.199		344 x 509 x 182	906 810 64 16
		51.5892.311.199		344 x 460 x 182	906 810 55 16 + 906 810 25 93
		51.5892.312.199 *		344 x 460 x 182	906 810 37 93
		51.5892.313.199		344 x 460 x 182	906 810 67 16
		51.5895.312.199 *		344 x 460 x 182	906 810 80 93

R H D	L H D	51.5892.211.199		344 x 460 x 182	906 810 53 16 + 906 810 23 93
		51.5892.212.199 *		344 x 460 x 182	906 810 35 93
		51.5892.213.199		344 x 460 x 182	906 810 65 16
		51.5892.411.199		344 x 509 x 182	906 810 54 16 + 906 810 24 93
		51.5892.413.199		344 x 509 x 182	906 810 66 16
	51.5895.412.199 *		344 x 509 x 182	906 810 79 93	

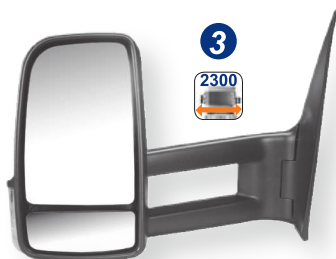

R H D	L H D	51.5893.111.199		344 x 543 x 182	906 810 56 16 + 906 810 26 93
		51.5893.112.199 *		344 x 543 x 182	906 810 38 93
		51.5893.113.199		344 x 543 x 182	906 810 68 16
		51.5893.211.199		344 x 511 x 182	906 810 57 16 + 906 810 27 93
		51.5893.212.199 *		344 x 511 x 182	906 810 39 93
		51.5893.213.199		344 x 511 x 182	906 810 69 16

* mit beheizter Weitwinkel - Glaseinheit,
nur verwendbar für Fahrzeuge ab "EURO 5"
with heated wide angle mirror glass unit,
suitable from "EURO 5" vehicles only

MERCEDES

589

II III e1 03★0006

II III E1 020902



Beschreibung
description
description
description
description
benamning
Popis
omircauwe
brevlik
leirats
opis



OE

15.5891.741H		236 x 155 x 16	002 811 15 33	a
15.5891.742H		236 x 155 x 16	002 811 16 33	
15.5891.611H		154 x 59 x 19	002 811 19 33	b
15.5891.612H		154 x 59 x 19	002 811 20 33	
19.5890.011.099		240 x 158 x 21	002 811 52 33	c
19.5890.012.099		240 x 158 x 21	002 811 53 33	
19.5891.011.099		240 x 158 x 21	002 811 56 33	
19.5891.012.099		240 x 158 x 21	002 811 57 33	
08.5890.300.099		113 x 32 x 15	000 440 00 15	
08.5890.301.099		113 x 32 x 15	000 440 01 15	
15.5891.721.099		157 x 65 x 20	002 811 39 33	d
15.5891.722.099		157 x 65 x 20	002 811 40 33	
13.5890.110.199		344 x 218 x 82	000 811 10 22	
13.5890.210.199		344 x 218 x 82	000 811 11 22	
13.5890.120.099		344 x 201 x 82	001 811 00 22	
13.5890.220.099		344 x 201 x 82	001 811 01 22	
14.5890.100.099		337 x 192 x 56	000 813 04 36	
14.5890.200.099		337 x 192 x 56	000 813 05 36	
08.5892.001.099		13 133 x 118 x 88	001 822 89 20 + 000 820 12 77	
08.5892.002.099		13 133 x 118 x 88	001 822 93 20 + 000 820 12 77	
08.5892.003.099		13 133 x 118 x 88	001 822 90 20 + 000 820 12 77	
08.5892.004.099		13 133 x 118 x 88	001 822 92 20 + 000 820 12 77	
08.5892.105.099		12 51 x 27 ø	000 820 12 77	

Mercedes Sprinter II (NCV3) 10/05 - 09/10



Sprinter II Euro 5 + 6 10/2010 - 11/2017

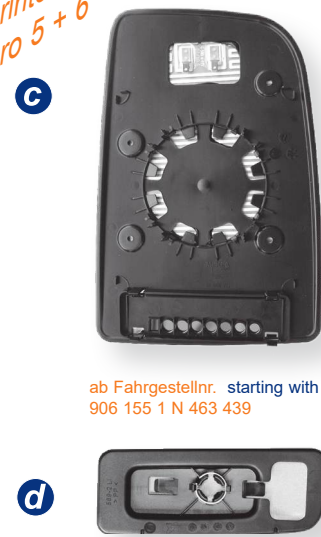

ab Fahrgestellnr. starting with chassis no. 906 155 1 N 463 439



ab Fahrgestellnr. starting with chassis no. 906 155 1 N 416 545



MERCEDES

1039

II (E1) 041469



INTEGR.



Beschreibung
description
descripción
descricao
benamning
popsis
omicauwe
ბრელიკი
опis



Sprinter III
W907 und W910

2018



1

L H D	1	59.1039.125.099							423 x 280 x 160	9108100300	
		59.1039.225.099							423 x 280 x 160	9108100400	
		59.1039.101.099							423 x 280 x 160	9108108901	
		59.1039.201.099							423 x 280 x 160	9108109001	
		59.1039.105.099							423 x 280 x 160	9108101900	
		59.1039.205.099							423 x 280 x 160	9108102000	
	R H D		59.1039.175.099							423 x 280 x 160	9108100500
			59.1039.275.099							423 x 280 x 160	9108100600
			59.1039.151.099							423 x 280 x 160	9108109101
			59.1039.251.099							423 x 280 x 160	9108109201
			59.1039.158.099							423 x 280 x 160	9108109501
			59.1039.258.099							423 x 280 x 160	9108109601
			59.1039.155.099							423 x 280 x 160	9108102100
	59.1039.255.099							423 x 280 x 160	9108102200		
L H D	2	61.1039.106.199							423 x 246 x 194	9108115700	
		61.1039.206.199							423 x 246 x 194	9108115800	

04/2024

Sprinter III
W907 und W910



2

Für Fahrzeuge mit 360° Kamerasystem
(Kamera bei Mercedes erhältlich)

For vehicles with 360° camera system
(camera available from Mercedes)

MERCEDES

1039 II (E1) 041469 **INTEGR.**

 Beschreibung description description descripción descripción benámining P-popis övireauwe letráls optis mm

19.1039.411.099		1	207 x 139 x 20	9108112500
19.1039.412.099		1	207 x 139 x 20	9108112400
19.1039.011.099		1	207 x 139 x 20	9108112700
19.1039.012.099		1	207 x 139 x 20	9108112600
19.1039.811.099		2	207 x 139 x 20	9108112900
19.1039.812.099		2	207 x 139 x 20	9108112800
19.1039.311.099		3	137 x 70 x 20	9108113700
19.1039.312.099		3	137 x 70 x 20	9108113600
13.1039.001.099		4	308 x 216 x 104	9108114100
13.1039.002.099		4	308 x 216 x 104	9108114000
13.1039.007.099		5	308 x 216 x 102	9108116100
13.1039.008.099		5	308 x 216 x 102	9108116200
11.1039.011.099		6	308 x 189 x 60	9108113900
11.1039.012.099		6	308 x 189 x 60	9108113800
08.1039.011.099		7	Ø 15x 38	9109065600
61.1039.002.099		8	Ø 19 x 36	9108250400
08.1039.001.099		9	87 x 67 x 54	9109064700
08.1039.002.099		9	87 x 67 x 54	9109064600
11.1039.001.099		10	62 x 87 x 27	9108114500
11.1039.002.099		10	62 x 87 x 27	9108114400
08.1039.005.099		11	35 x 42 x 12	9105420100
08.1039.006.099		11	35 x 42 x 12	9105420000
61.1039.005.099		12	130 x 100 x 25	9108115500
61.1039.007.099		13	35 x 50 x 45	9108116300
08.1039.024.099		14	38 x 46 x 20	9109060601
12.1039.031.099		15	253 x 187 x 66	9108110000
12.1039.032.099		15	253 x 187 x 66	9108110300
08.1039.009.099		16	85 x 85 x 45	9108208200

*Sprinter III
W907 und W910*



MERCEDES



2018

MERCEDES

Sprinter III
W907 und W910

1039	II III (E1) 02★0902			INTEGR.
-------------	---------------------	--	--	----------------

	Beschreibung description description descrição descrizione benámení popis описание özet rekras opis		
--	---	--	--



LHD	1	59.1039.501.099					423 x 447 x 270	9108100801
		59.1039.601.099					423 x 447 x 270	9108100901
RHD		59.1039.575.099					423 x 447 x 270	9108100601
		59.1039.675.099					423 x 447 x 270	9108100701
		59.1039.551.099					423 x 447 x 270	9108101001
		59.1039.651.099					423 x 447 x 270	9108101101
LHD	2	61.1039.502.099					423 x 484 x 352	9108108102
		61.1039.602.099					423 x 420 x 202	9108108202
LHD	3	59.1039.701.099					423 x 502 x 343	9108101601
		59.1039.801.099					423 x 502 x 343	9108101701
LHD	4	61.1039.702.099					423 x 517 x 306	9108108502
		61.1039.802.099					423 x 481 x 173	9108108602



MERCEDES

MERCEDES

1039

II (E1) 041469
II (E1) 02★0902



Beschreibung
description
description
descripção
descripzione
benamining
popis
oniçcauwe
brailik
prijās
opis



19.5890.011.099		1	240 x 158 x 21	0028115233
19.5890.012.099		1	240 x 158 x 21	0028115333
19.1039.813.099		2	240 x 158 x 21	9108114900
19.1039.814.099		2	240 x 158 x 21	9108114800
15.5891.721.099		3	157 x 65 x 20	0028113933
15.5891.722.099		3	157 x 65 x 20	0028114033
13.5890.110.199		4	344 x 218 x 82	0008111022
13.5890.210.199		4	344 x 218 x 82	0008111122
13.5890.120.099		5	344 x 218 x 82	0018110022
13.5890.220.099		5	344 x 218 x 82	0018110122
14.5890.100.099		6	337 x 192 x 56	0008130436
14.5890.200.099		6	337 x 192 x 56	0008130536
08.5892.105.099		7	Ø 25 x 51	0008201277
08.5892.002.099		8	133 x 118 x 88	0018229320 + 0008201277
08.5892.003.099		8	133 x 118 x 88	0018229420 + 0008201277
61.1039.006.099		9	170 x 75 x 35	9108115600
12.1039.031.099		10	253 x 187 x 66	9108110000
12.1039.032.099		10	253 x 187 x 66	9108110300
08.1013.101.099		11	75 x 84 x 38	9108208300
08.1013.001.099		11	75 x 84 x 38	0008208708

Sprinter III
W907 und W910



MERCEDES

2024

Opel Movano

OPEL

1048 **NEW** II e3 09★1044 INTEGR.

mm

	59.1048.012.099	59.1048.013.099	59.1048.014.099	59.1048.015.099	59.1048.016.099	19.1048.001.099	19.1048.002.099	19.1048.003.099	19.1048.004.099	19.1048.005.099	19.1048.006.099	08.1048.003.099	08.1048.004.099
1	12V f-sensor	12V	12V FM	12V f-sensor	12V FM	12V 1200 1	12V 1200 1	400 2	400 12V 2	12V 1200 BSM 3	12V 1200 BSM 3	16W 2022 5	16W 2022 5
	410 x 360 x 161	410 x 360 x 161	410 x 360 x 161	485 x 430 x 170	485 x 430 x 170	269 x 193 x 29	269 x 193 x 29	77 x 187 x 24	77 x 187 x 24	269 x 193 x 29	269 x 193 x 29	130 x 71 x 60	130 x 71 x 60



1



2



Blind Spot Modul

Das Blind Spot Modul ist im Lieferumfang enthalten.
The Blind Spot Modul is included in the delivery!



4



2024

Electronics and Accessories

Product Catalog for Camera Monitor Systems and Active Alarm Systems

Download



Peugeot Boxer
2006 - 2023

PEUGEOT

1048	NEW	II e3 09★1044		INTEGR.
------	------------	---------------	--	---------

	Beschreibung description description descricao descriptione benamning popis omivcawke beilags opis		OE
--	---	--	----



1

1	59.1048.001.099		410 x 360 x 161	1613689280* 1613691980* 1635187780* 1685327280* 8154LR* 815428
	59.1048.002.099		410 x 360 x 161	1613693180* 1635685380
	59.1048.007.099		410 x 360 x 161	1611711480* 1650901780* 1685332280* 735690575* 735773338* 735773346
	59.1048.008.099		410 x 360 x 161	
	59.1048.009.099		410 x 360 x 161	1685327480
	59.1048.010.099		410 x 360 x 161	1666450680* 1685329880
	59.1048.011.099		410 x 360 x 161	1660711580* 1685327680



2

2	59.1048.003.099		485 x 430 x 170	1613692780* 1613693380* 1635193380* 1635685280* 1685330080* 8153PR* 8153Y0* 8154LZ
	59.1048.004.099		485 x 430 x 170	1613689480* 1635685780* 1685328180* 8153NS* 8153W3* 8154KV* 815430
	59.1048.005.099		485 x 430 x 170	1613692780* 1635685280* 8153PL* 8153X6* 8154LZ* 815459
	59.1048.006.099		485 x 430 x 170	1611711880* 1635683380* 1635683380* 8153PE* 8153X2* 8154PH* 815439

1 + 2	19.1048.001.099		269 x 193 x 29	8151LJ
	19.1048.002.099		269 x 193 x 29	8151LK
	19.1048.003.099		77 x 187 x 24	8151LP
	19.1048.004.099		77 x 187 x 24	8151LQ
	19.1048.005.099		269 x 193 x 29	1666450580* 1666450680
	19.1048.006.099		269 x 193 x 29	735706880* 735706881* 735706882 735706684* 735706885* 765706886
	08.1048.001.099		130 x 71 x 60	6325H3
	08.1048.002.099		130 x 71 x 60	6325H4
	08.1048.003.099		130 x 71 x 60	1688409580
	08.1048.004.099		130 x 71 x 60	1688409680



Blind Spot Modul

Das Blind Spot Modul ist im Lieferumfang enthalten.
The Blind Spot Modul is included in the delivery!



4



5

PEUGEOT

1048	NEW	II e3 09★1044		INTEGR.
------	------------	---------------	--	---------

MEKRA LANG Group	Beschreibung description descripção descripziune benamning popis opis/cawne bërellik veivās opis				mm	OE
	Icons	Icons	Icons	Icons		
59.1048.012.099	[Icons]	[Icons]	[Icons]	[Icons]	410 x 360 x 161	1
59.1048.013.099	[Icons]	[Icons]	[Icons]	[Icons]	410 x 360 x 161	
59.1048.014.099	[Icons]	[Icons]	[Icons]	[Icons]	410 x 360 x 161	
59.1048.015.099	[Icons]	[Icons]	[Icons]	[Icons]	485 x 430 x 170	2
59.1048.016.099	[Icons]	[Icons]	[Icons]	[Icons]	485 x 430 x 170	
19.1048.001.099	[Icons]	[Icons]	[Icons]	[Icons]	269 x 193 x 29	1
19.1048.002.099	[Icons]	[Icons]	[Icons]	[Icons]	269 x 193 x 29	1
19.1048.003.099	[Icons]	[Icons]	[Icons]	[Icons]	77 x 187 x 24	2
19.1048.004.099	[Icons]	[Icons]	[Icons]	[Icons]	77 x 187 x 24	2
19.1048.005.099	[Icons]	[Icons]	[Icons]	[Icons]	269 x 193 x 29	3
19.1048.006.099	[Icons]	[Icons]	[Icons]	[Icons]	269 x 193 x 29	3
08.1048.003.099	[Icons]	[Icons]	[Icons]	[Icons]	130 x 71 x 60	5
08.1048.004.099	[Icons]	[Icons]	[Icons]	[Icons]	130 x 71 x 60	5

Peugeot Boxer



1



Blind Spot Modul

Das Blind Spot Modul ist im Lieferumfang enthalten.
The Blind Spot Modul is included in the delivery!



2



RENAULT

390	II 03★0009			Ø 28 mm
	II 020914			
	IV 03★0010			
	IV 020913			

	Beschreibung		
	description		
	descripção		
	descripção		
	benamning		
	popis		
	omicaune		
	üzeylik		
	telrás		
	опis		

Midlum	Part Number	Icons	Dimensions (mm)	OE Part Number
	58.3900.143H		800 x 270	7420903722
	58.3900.243H		800 x 270	7420903727
	58.3900.133H		800 x 350	7420903723
	58.3900.233H		800 x 350	7420903732
	58.3900.333H		800 x 350	7420914934
	58.3900.433H		800 x 350	7420914938
	15.3911.871H		200 x 197 x 75	7420862810
	15.3911.872H		200 x 197 x 75	7420862815
	61.3911.110H		245 x 236 x 105	7420862809
	61.3911.120H		245 x 236 x 105	7420862813
	11.3900.200H		371 x 244 x 80	7420862779
	11.3910.200H		244 x 225 x 75	7420862800
	15.3900.840H		337 x 202 x 25	7420862795
	08.5752.024.099		130 x 120 x 53	7421618499
	61.3900.130H		373 x 245 x 101	7485120820
	61.3900.100H		373 x 245 x 101	7420862782
	61.3900.110H		373 x 245 x 101	7420866665
	61.3900.120H		373 x 245 x 101	7420913815
	20.3900.510H		518 x 160 x 98	5010623057
	20.3900.520H		518 x 160 x 98	5010623058

	58 3900 143H		800 x 270	7420903722
	58 3900 243H		800 x 270	7420903727
	61.3910.110H		245 x 236 x 105	7420904268
	61.3910.120H		245 x 236 x 105	7420904269
	15.3910.871H		203 x 189 x 75	7420903745
	15.3910.872H		203 x 189 x 75	7420903746
	11.3900.100H		371 x 244 x 80	7420903880
	11.3910.110H		303 x 244 x 75	7420903882
	11.3910.120H		303 x 244 x 75	7420903883

1033	II 024559			INTEGR.
	IV 024559			

	Beschreibung		
	description		
	descripção		
	descripção		
	benamning		
	popis		
	omicaune		
	üzeylik		
	telrás		
	опis		

	19.1033.001.199		365 x 200	7482408450
	19.1033.002.199		201 x 191	7482408451

Renault Midlum
Premium Distribution 05/2006 - 09/2013
Kerax
Renault D-Serie 10/2013 - 01/2024
C-Serie (2,3m)
Renault Premium Route 10/2005 - 09/2023



06/13

T-Series



RENAULT

1000

II (E) 021108
IV (E) 021109



ABS

INTEGR.



Beschreibung
description
description
description
description
Pops
ovircauwe
birellik
letrās
opts



OE

59.1000.611.199		kurz short	1	890 x 439 x 180	7424680566
59.1000.612.199		kurz short	1	890 x 441 x 180	7424680570
59.1000.613.199		kurz short	1	890 x 439 x 180	7424680572
59.1000.614.199		kurz short	1	890 x 441 x 180	7424680575
59.1000.641.199		mittel medium	1	890 x 490 x 180	7424680579
59.1000.642.199		mittel medium	1	890 x 483 x 180	7424680584
59.1000.621.199		lang long	1	890 x 539 x 180	7424680595
59.1000.622.199		lang long	1	890 x 530 x 180	7424680600
59.1000.623.199		lang long	1	890 x 539 x 180	7424680606
59.1000.624.199		lang long	1	890 x 530 x 180	7424680610
58.1000.611.199		kurz short	1	890 x 439 x 28 ø	7424384079
58.1000.612.199		kurz short	1	890 x 441 x 28 ø	7424384933
58.1000.613.199		kurz short	1	890 x 439 x 28 ø	7424384963
58.1000.614.199		kurz short	1	890 x 441 x 28 ø	7424384872
58.1000.641.199		mittel medium	1	890 x 490 x 28 ø	7424384743
58.1000.642.199		mittel medium	1	890 x 483 x 28 ø	7424384935
58.1000.621.199		lang long	1	890 x 539 x 28 ø	7424384744
58.1000.622.199		lang long	1	890 x 530 x 28 ø	7424384936
58.1000.623.199		lang long	1	890 x 539 x 28 ø	7424384969
58.1000.624.199		lang long	1	890 x 530 x 28 ø	7424384925
61.1000.105.199		KIT	9	81 x 76 x 45	7484214269
61.1000.006.199		KIT	7	130 x 127 x 65	7423229803
61.1000.007.199		KIT	8	130 x 127 x 65	7423227102
13.1000.601.199			3	393 x 210 x 46	7424384063
13.1000.602.199			3	393 x 210 x 46	7424384871
13.1000.603.199			5	210 x 208 x 54	7424384076
19.1000.601.199		24 V 1200	2	387 x 205 x 41	7424384062
19.1000.602.199		24 V 1200	2	387 x 205 x 41	7424384748
19.1000.603.199		24 V 300	4	205 x 205 x 55	7424384060
09.1000.400.199		temperature sensor		215	7424384873
20.1000.611.199		für für pour	6	519 x 160 x 100	7424382986
20.1000.612.199		für für pour	6	519 x 160 x 100	7424486092
20.1000.613.199		für für pour t. sensor	6	519 x 160 x 100	7424486090
20.1000.614.199		für für pour t. sensor	6	519 x 160 x 100	7424382989

Renault D-Serie
E-Tech D
01/2024



1



1



2



3



4



5



6



7



8



9

RENAULT

RENAULT

552-1	V VI 03★0033			INTEGR.
	V VI 020894			

	Beschreibung / description / descrição / descripción / benámenění / popis / ovrkcauwe / őzellik / leírás / opis						OE
	59.5524.648.099		1	725 x 319 x 126	7420849837 + 7482226025		
51.5524.930H				316 x 186 x 77	7421020285		
59.5524.649.099		2	437 x 319 x 103	7420849835 + 7482226027			
51.5524.930H			316 x 186 x 77	7421020285			

348	II 03★0184			Ø 22 mm
	II 021022			

	Beschreibung / description / descrição / descripción / benámenění / popis / ovrkcauwe / őzellik / leírás / opis						OE
	61.3481.149H		1	395 x 205 x 145	5001856290		
15.3480.840H				372 x 189 x 32			
11.3480.100				169 x 88 x 27			
61.3480.149H		2	382 x 193 x 85	5001853675 + 5001856292 5001833026			
40.3485.412H			375 x 190 x 3				

348	IV 03★0185			Ø 22 mm
	IV 021023			

	Beschreibung / description / descrição / descripción / benámenění / popis / ovrkcauwe / őzellik / leírás / opis						OE
	61.3482.149H		1	199 x 199 x 97	7421276373		
40.3485.403H				191 x 191 x 3			

558	V 03★0011			
	V 020912			

	Beschreibung / description / descrição / descripción / benámenění / popis / ovrkcauwe / őzellik / leírás / opis						OE
	59.5580.247H		1	260 x 229 x 70	5010578511		

1025	V 04★1345			

	Beschreibung / description / descrição / descripción / benámenění / popis / ovrkcauwe / őzellik / leírás / opis						OE
	59.1025.001.099		1	315 x 179 x 220	7484531138		
59.1025.002.099				315 x 179 x 220	7484531168		

New Regulation ECE R46/04

Premium Route 2711 10/05 - 09/13
 Midlum 1818 05/06 - 09/13
 Premium Distribution 05/06 - 09/13
 Kerax 10/13
 D-Serie 10/13
 C-Serie (2,3 m)



Premium, Gamme R/G 09/2005
 Midlum / Kerax



D-Serie 10/13
 C-Serie (2,3 m) 10/13



2010

RENAULT

1047	NEW	II E9 02★4501			INTEGR.
		II E9 02★4507			

	Beschreibung		mm	OE
	description			
	descripção			
	descricao			
	benamning			
	popis			
	onyrcauue			
	leirás			
	opis			

59.1047.001.099			505 x 240 x 330	963021976R / 963020133R	1
59.1047.002.099		t. sensor	505 x 240 x 330	963016903R / 963010146R	
59.1047.003.099			505 x 240 x 412	963020218R / 963020135R	2
59.1047.004.099		t. sensor	505 x 240 x 412	963018382R / 963010148R	
19.1047.001.099			250 x 164 x 20	963662420R	1 + 2
19.1047.002.099			250 x 164 x 20	963655132R	
19.1047.003.099			73 x 154 x 27	7701057370	2
19.1047.004.099			73 x 154 x 27	7701058200	
08.1047.001.099			62 x 120 x 60	261603141R	1
08.1047.002.099			62 x 120 x 60	261652475R	



SCANIA

Serie 4 (NGS)
Serie R/P/T/G

95 - 07/04
08/04 →



400				INTEGR.
MEKRA LANG Group		mm		OE
Beschreibung description descrição descrizione benämning popis оригинале üzeylik leirás opis				
15.4001.840H				
		432 x 200 x 20	176 5985	
15.4001.740H				
		184 x 160 x 20	176 7265	

Komplettspiegel erhältlich bei SCANIA
complete mirror available at SCANIA

Serie 4 R/P/T/G

08/04 →



1005	V 04★1336 V 041336			
MEKRA LANG Group		mm		OE
Beschreibung description descrição descrizione benämning popis оригинале üzeylik leirás opis				
59.1005.003.099				
		326 x 202 x 214	2382791	

New Regulation ECE R46/04







Serie L/P/G

2016 →



1020	V 041389			INTEGR.
MEKRA LANG Group		mm		OE
Beschreibung description descrição descrizione benämning popis оригинале üzeylik leirás opis				
56.1020.020.099				
		307 x 279 x 95	2116023	
56.1020.021.099				
		307 x 279 x 95	2645660	
19.1020.213.099				
		297 x 172 x 62	2249381	
19.1020.613.099				
		297 x 172 x 62	2249382	
12.1020.003.099				
		191 x 137 x 41	2118477	
08.1024.124.099				
		130 x 120 x 45	3139595	

SCANIA

1019	II (E1) 041391 IV (E1) 041392		
	Beschreibung description descriþtion descriþção descrizione beschriþþion benamning þopps описаниe öreilikk leirrás opis		OE
19.1019.013.099		400 x 208 x 29	2116845
19.1019.014.099		400 x 208 x 29	2116846
19.1019.313.099		219 x 196 x 39	2116848
19.1019.314.099		219 x 196 x 39	2116849

Serie L/P/G



2016

F7, F 10, F 12
12/77 - 08/85



250		II 01★14002				Ø 14-20 mm
MEKRA LANG Group		Beschreibung description descripção descripziõe descripciön benamning popis omicaawe üzellik leirras opis				OE
51.2500.127H		375 x 183 x 26	1581 550			
40.2500.222H		366 x 176 x 3	1581 599			
51.2500.147H		375 x 183 x 26	1594 412 + 1581 616 1594 411			
40.2500.422H		366 x 176 x 3	1581 602 + 1594 415			
09.2070.101H		2070 x 9 Ø	2108 3541			

FL 4, FL 6, FL 7, FL 10
F 10, F 12, F 16
NL 10, NL 12
09/85 - 9/94
09/85 - 9/93
1972 - 8/85



252		II 02★14089 II 0114089				Ø 14-20 mm
MEKRA LANG Group		Beschreibung description descripção descripziõe descripciön benamning popis omicaawe üzellik leirras opis				OE
51.2520.127H		444 x 208 x 84	1599 462 + 3090 395			
40.2520.222H		429 x 194 x 3	1697 007 + 2085 4576			
51.2520.147H		444 x 208 x 84	1594 902 + 1621 353 1195 934 + 3090 396			
40.2520.422H		429 x 194 x 3	1697 008 + 3093 519			
09.2070.101H		2070 x 9 Ø	2108 3541			

FH
FM
NH
10/93 - 03/02
08/98 - 03/02
05/99

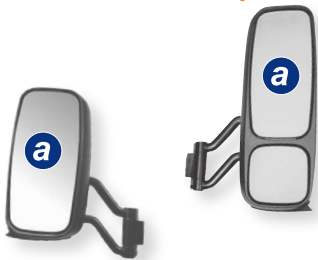

370 371		II 02★14125 II 0114125				INTEGR.
MEKRA LANG Group		Beschreibung description descripção descripziõe descripciön benamning popis omicaawe üzellik leirras opis				OE
15.3702.470H		433 x 198 x 16	3090 737 + 3091 756 3092 854 + 2085 4564			

FH I + FH II
FM I + FM II
1



360 360-1		V 02★12013 V 0112013 V 03★0039 V 020973				
MEKRA LANG Group		Beschreibung description descripção descripziõe descripciön benamning popis omicaawe üzellik leirras opis				OE
59.3601.128H		284 x 174 x 62	1096 643			
40.3605.204F		272 x 162 x 3	3090 734 + 2085 4583			
59.3601.178H		284 x 174 x 64	2120 3313			
40.3605.203H		272 x 162 x 3				
59.3601.188H		284 x 174 x 64				
40.3605.403H		272 x 162 x 3				
59.3602.128H		284 x 174 x 62	3126 117			
40.3605.204F		272 x 162 x 3	3090 734 + 2085 4583			

VOLVO

390	II (E) 021108			Ø 28 mm
	II (E) 03★0242			
	IV (E) 021109			
	IV (E) 03★0243			

MEKRA LANG Group	Beschreibung description description descripção description benamning popis описување özellik leirás opis				mm	OE
58.3900.143H				kurz short	800 x 270	20903722
58.3900.243H				kurz short	800 x 270	20903727
58.3900.133H				lang long	800 x 350	20903723
58.3900.233H				lang long	800 x 350	20903732
58.3900.333H				lang long	800 x 350	20914934
58.3900.433H				lang long	800 x 350	20914938
15.3900.840H				24 V 1200	337 x 202 x 25	20862795
15.3911.871H				24 V 300	200 x 197 x 75	20862810
15.3911.872H				24 V 300	200 x 197 x 75	20862815
61.3900.100H					373 x 245 x 101	20862782
61.3900.110H					373 x 245 x 101	20866665
61.3900.130H				für for pour	373 x 245 x 101	85120820
61.3911.110H					245 x 236 x 105	20862809
61.3911.120H					245 x 236 x 105	20862813
11.3900.200H					371 x 244 x 80	20862779
11.3910.200H					244 x 225 x 75	20862800
08.5752.024.099					130 x 120 x 53	21618499
20.3900.510H				für for pour	518 x 160 x 98	20708110
20.3900.520H				für for pour	518 x 160 x 98	20708230

FL / FE

09/2006 - 01/2024



552-1	V VI (E1) 03★0033			INTEGR.
	V VI (E1) 020894			

MEKRA LANG Group	Beschreibung description description descripção description benamning popis описување özellik leirás opis				mm	OE
59.5524.648.099					725 x 319 x 126	2084 9837
51.5524.930H				300	316 x 186 x 77	2102 0285



VOLVO

01/2024 →
Volvo FL/FE

VOLVO

1000	II (E) 021108 IV (E) 021109			INTEGR.
	Beschreibung description description description benámenění pops omrcauwe üzeilikk reirras ops		mm	



Part No.	Icons	Unit	Dimensions	Part No.
59.1000.611.199	[Icons]	1	890 x 439 x 180	24680566
59.1000.612.199	[Icons]	1	890 x 441 x 180	24680570
59.1000.613.199	[Icons]	1	890 x 439 x 180	24680572
59.1000.614.199	[Icons]	1	890 x 441 x 180	24680575
59.1000.641.199	[Icons]	1	890 x 490 x 180	24680579
59.1000.642.199	[Icons]	1	890 x 483 x 180	24680584
59.1000.621.199	[Icons]	1	890 x 539 x 180	24680595
59.1000.622.199	[Icons]	1	890 x 530 x 180	24680600
59.1000.623.199	[Icons]	1	890 x 539 x 180	24680606
59.1000.624.199	[Icons]	1	890 x 530 x 180	24680610
58.1000.611.199	[Icons]	1	890 x 439 x 28 ø	24384079
58.1000.612.199	[Icons]	1	890 x 441 x 28 ø	24384933
58.1000.613.199	[Icons]	1	890 x 439 x 28 ø	24384963
58.1000.614.199	[Icons]	1	890 x 441 x 28 ø	24384872
58.1000.641.199	[Icons]	1	890 x 490 x 28 ø	24384743
58.1000.642.199	[Icons]	1	890 x 483 x 28 ø	24384935
58.1000.621.199	[Icons]	1	890 x 539 x 28 ø	24384744
58.1000.622.199	[Icons]	1	890 x 530 x 28 ø	24384936
58.1000.623.199	[Icons]	1	890 x 539 x 28 ø	24384969
58.1000.624.199	[Icons]	1	890 x 530 x 28 ø	24384925
61.1000.105.199	[Icons]	9	81 x 76 x 45	84214269
61.1000.006.199	[Icons]	7	130 x 127 x 65	23229803
61.1000.007.199	[Icons]	8	130 x 127 x 65	
13.1000.601.199	[Icons]	3	393 x 210 x 46	24384063
13.1000.602.199	[Icons]	3	393 x 210 x 46	24384871
13.1000.603.199	[Icons]	5	210 x 208 x 54	24384076
19.1000.601.199	[Icons]	2	387 x 205 x 41	24384062
19.1000.602.199	[Icons]	2	387 x 205 x 41	24384748
19.1000.603.199	[Icons]	4	205 x 205 x 55	24384060
09.1000.400.199	[Icons]		215	24384873
20.1000.611.199	[Icons]	6	519 x 160 x 100	24382986
20.1000.612.199	[Icons]	6	519 x 160 x 100	24486092
20.1000.613.199	[Icons]	6	519 x 160 x 100	24486090
20.1000.614.199	[Icons]	6	519 x 160 x 100	24382989



VOLVO

1000 1043/1044	II ☎ 041541 IV ☎ 041540	II ☎ 021108 II ☎ 03★0242 IV ☎ 021109 IV ☎ 03★0243	I + IV Truck	ASA	INTEGR.
--------------------------	----------------------------	--	-----------------	-----	---------

	Beschreibung description description description benamining Pops omicaawie birellik letrals opis	mm 	OE
--	---	--------	----

Part No.	Icons	Code	Dimensions	Description
51.1043.001.099		a	413 x 203 x 75	OE offers only components
51.1043.002.099		a	413 x 203 x 75	OE offers only components
51.1044.001.099		b	204 x 209 x 88	OE offers only components
51.1044.002.099		b	204 x 209 x 88	OE offers only components
09.1000.200.099		1	250	
19.1043.001.099		a	406 x 199 x 40	
19.1044.001.099		b	199 x 204 x 54	
13.1043.001.000		a	413 x 203 x 47	
13.1044.001.000		b	204 x 209 x 54	
19.1000.101.099		c	387 x 205 x 41	82356810
19.1000.121.099		2 c	387 x 205 x 41	24015370
19.1000.102.099		d	387 x 205 x 41	82359214
19.1000.122.099		2 d	387 x 205 x 41	24015373
19.1000.103.099		e	205 x 205 x 55	82356824
61.1000.004.099			130 x 127 x 65	23227102

1 Anschlusskabel (Austausch) für Heizung ab Bj. 05/2019
heating cable for replacement for vehicles from 05/2019



VOLVO FH 4
 VOLVO FMX
 VOLVO FMD

10/12
 10/15
 2020

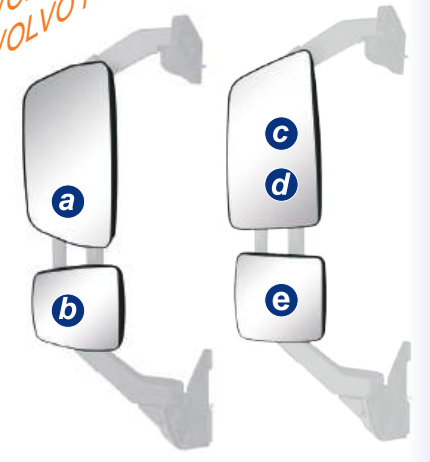

Das Blind Spot Modul ist im Lieferumfang nicht enthalten!
The Blind Spot Modul is not included in the delivery!

FL/FE



09/06

New Regulation ECE R46/04

1025		V e1 04★1345				
		Beschreibung description descripção descripziõe descripziõn benämning popis omicaune üzellik leirás opis				OE
59.1025.001.099				315 x 179 x 220	8453 1138	
59.1025.002.099				315 x 179 x 220	8453 1168	

FH 2 / FM 2



04/02 - 09/2012

224		II e1 03★0031				INTEGR.
		Beschreibung description descripção descripziõe descripziõn benämning popis omicaune üzellik leirás opis				OE
15.2240.840H						431 x 197 x 30 2056 7670 + 2132 0383

Komplettspiegel erhältlich bei VOLVO
complete mirror available at VOLVO

FMX



10/10 - 12/2015

572		II e1 03★0031				∅ 22 / 28 mm
		II E1 020918				OE
61.5721.006.099				426 x 200 x 135	8247 1690	
61.5721.005.099				426 x 200 x 135	8247 1688	
40.5725.412H					412 x 188 x 3 8241 7041	
61.5721.004.099				78 x 69 x 38	8247 2612	
11.5721.001.099				427 x 199 x 36	8241 7042	
08.5380.004.000				72 x 75 x 36		



573		IV e1 03★0032				∅ 22 / 28 mm
		IV E1 020917				OE
61.5731.001.099				202 x 198 x 126	8247 1689	
40.5735.403H					190 x 184 x 3 8241 7044	
61.5721.004.099				78 x 69 x 38	8247 2612	
11.5731.001.099				202 x 198 x 27	8241 7045	

VOLVO

01/96



349 349 TW	II e1 02★0384 II (E1) 010384	II		INTEGR.
-----------------------------	---------------------------------	----	--	---------

	Beschreibung description description description benämning popis özvejlék leírás opis		OE
--	---	--	----



15.3491.071H		238 x 142 x 6	2D0 857 521	1
15.3491.072H		238 x 142 x 6	2D0 857 522	
15.3491.371H		238 x 142 x 6	2D0 857 521 A	
15.3491.372H		238 x 142 x 6	2D0 857 522 A	
56.3491.110H		175 x 116 x 70		2
15.2711.214H		165 x 93 x 15		
56.3492.110H		175 x 116 x 70		
15.2711.214H		165 x 93 x 15		

LT



Volkswagen
LT (Crafter)
05/2006 - 02/2017



589	II III e1 03★0006 II III E1 020902			INTEGR.
------------	---------------------------------------	---	---	----------------









































mm







* mit beheizter Weitwinkel - Glaseinheit, nur verwendbar für Fahrzeuge ab "EURO 5" with heated wide angle mirror glass unit, suitable from "EURO 5" vehicles only

		Beschreibung description description description benamning popsis ömr/cawne reírás opis					
LHD	1	51.5891.111.199		344 x 315 x 182	2E1 857 501 E 2E1 857 501 AJ		
		51.5891.112.199 *	 12V	344 x 315 x 182	2E1 857 501 Q		
		51.5891.113.199	 12V	344 x 315 x 182	2E1 857 501 F		
		51.5891.114.199 *	 12V PARK PILOT	344 x 315 x 182	2E3 857 501 J		
	RHD		51.5894.112.199 *	 12V ohne w/o sans	344 x 315 x 182	2E0 857 513 C	
			51.5891.311.199		344 x 345 x 182	2E2 857 501 C 2E2 857 501 N	
			51.5894.310.199	 ohne w/o sans	344 x 345 x 182	2E0 857 513 B	
			51.5891.312.199 *	 12V	344 x 345 x 182	2E2 857 501 F	
			51.5891.313.199	 12V	344 x 345 x 182	2E2 857 501 D	
		51.5891.314.199 *	 12V PARK PILOT	344 x 345 x 182	2E4 857 501 K		
LHD			51.5891.211.199		344 x 345 x 182	2E1 857 502 E 2E1 857 502 AK	
			51.5891.212.199 *	 12V	344 x 345 x 182	2E1 857 502 P	
			51.5891.213.199	 12V	344 x 345 x 182	2E1 857 502 F	
		51.5891.214.199 *	 12V PARK PILOT	344 x 345 x 182	2E3 857 502 K		
	RHD		51.5894.212.199 *	 12V ohne w/o sans	344 x 345 x 182	2E0 857 514 B	
			51.5891.411.199		344 x 315 x 182	2E2 857 502 C 2E2 857 502 N	
			51.5894.410.199	 ohne w/o sans	344 x 315 x 182	2E0 857 514 A	
			51.5891.412.199 *	 12V	344 x 315 x 182	2E2 857 502 F	
			51.5891.413.199	 12V	344 x 315 x 182	2E2 857 502 D	
		51.5891.414.199 *	 12V PARK PILOT	344 x 315 x 182	2E4 857 502 L		
LHD		2	51.5892.111.199		344 x 509 x 182	2E3 857 501 D 2E1 857 501 AK	
			51.5892.112.199 *	 12V	344 x 509 x 182	2E1 857 501 R	
			51.5892.113.199	 12V	344 x 509 x 182	2E3 857 501 F	
	RHD		51.5892.311.199		344 x 460 x 182	2E4 857 501 D 2E4 857 501 AD	
			51.5892.312.199 *	 12V	344 x 460 x 182	2E2 857 501 G	
			51.5892.313.199	 12V	344 x 460 x 182	2E4 857 501 F	
			51.5895.312.199 *	 12V ohne w/o sans	344 x 460 x 182	2E4 857 513 B	
		LHD		51.5892.211.199		344 x 460 x 182	2E1 857 502 D 2E1 857 502 AL
				51.5892.212.199 *	 12V	344 x 460 x 182	2E1 857 502 Q
			51.5892.213.199	 12V	344 x 460 x 182	2E3 857 502 F	
RHD				51.5892.411.199		344 x 509 x 182	2E4 857 502 E
				51.5892.413.199	 12V	344 x 509 x 182	2E4 857 502 G
			51.5895.412.199 *	 12V ohne w/o sans	344 x 509 x 182	2E4 857 514 B	
	LHD		3	51.5893.111.199		344 x 543 x 182	2E3 857 501 E 2E1 857 501 AL
				51.5893.112.199 *	 12V	344 x 543 x 182	2E3 857 501 H
				51.5893.113.199	 12V	344 x 543 x 182	2E3 857 501 G
			51.5893.211.199		344 x 511 x 182	2E3 857 502 E 2E1 857 502 AM	
			51.5893.212.199 *	 12V	344 x 511 x 182	2E3 857 502 J	
			51.5893.213.199	 12V	344 x 511 x 182	2E3 857 502 G	





589	II III e1 03★0006	II III
	II III E1 020902	II III

MEKRA LANG Group	Beschreibung description descripção descrizione description benamining Pops omircauwe birelik letras ops	mm	OE
------------------	--	----	----

15.5891.741H		236 x 155 x 16	2E1 857 587	a
15.5891.742H		236 x 155 x 16	2E1 857 588	
15.5891.611H		154 x 59 x 19	2E1 857 587 A	b
15.5891.612H		154 x 59 x 19	2E1 857 588 A	
19.5890.011.099		240 x 158 x 21	2E0 857 587 A	c
19.5890.012.099		240 x 158 x 21	2E0 857 588 A	
19.5891.011.099		240 x 158 x 21	2E0 857 587 B	d
19.5891.012.099		240 x 158 x 21	2E0 857 588 B	
08.5890.300.099		113 x 32 x 15	2E0 919 473	
08.5890.301.099		113 x 32 x 15	2E0 919 473 A	
15.5891.721.099		157 x 65 x 20	2E1 857 587 E	
15.5891.722.099		157 x 65 x 20	2E1 857 588 E	
13.5890.110.199		344 x 218 x 82	2E1 857 516 A	
13.5890.210.199		344 x 218 x 82	2E1 857 516 B	
13.5890.120.099		344 x 201 x 82	2E0 857 527	
13.5890.220.099		344 x 201 x 82	2E0 857 528	
14.5890.100.099		337 x 192 x 56	2E1 857 136	
14.5890.200.099		337 x 192 x 56	2E1 857 136 A	
08.5892.001.099		133 x 118 x 88	2E0 953 049 A + 2E0 945 981	
08.5892.002.099		133 x 118 x 88	2E0 953 049 C + 2E0 945 981	
08.5892.003.099		133 x 118 x 88	2E0 953 050 A or 2E0 953 050 C + 2E0 945 981	
08.5892.004.099		133 x 118 x 88	2E0 953 050 B or 2E0 953 049 B + 2E0 945 981	
08.5892.105.099		51 x 27 ø	2E0 945 981	

05/06 - 09/09

Volkswagen
LT (Crafter)



a



b

10/2009
Volkswagen
LT (Crafter) EURO 5 + 6



c



d





1013	NEW	II (E1) 041427			INTEGR.
-------------	------------	----------------	--	--	---------

	Beschreibung description descripção descripção descripção benamning popis описанье özellik leirás opis		mm	OE
--	--	--	----	----

61.1013.166.099		380 x 315 x 190	7CB 857 408 C	1 LHD
61.1013.266.099		380 x 330 x 200	7C1 857 408 N ♦ 7C1 857 408 J	RHD
61.1013.153.099		380 x 315 x 190	7C1 857 407 P	LHD
61.1013.253.099		380 x 330 x 200	7C1 857 408 P	RHD
61.1013.366.099		380 x 315 x 190	7C2 857 407 J ♦ 7C2 857 407 G	LHD
61.1013.466.099		380 x 330 x 200	7C2 857 408 J ♦ 7C2 857 408 G	RHD
61.1013.501.099		410 x 380 x 180	7CB 857 407 C	2 LHD
61.1013.651.099		410 x 380 x 190	7CB 857 408 E ♦ 7CB 857 408 C	RHD

Volkswagen NF (Crafter) 08/2017 →



1013	NEW	II (E1) 041427			
-------------	------------	----------------	--	--	--

	Beschreibung description descripção descripção descripção benamning popis описанье özellik leirás opis		mm	OE
--	--	--	----	----

19.1013.011.099		211 x 169 x 19	7C0857521G ♦ 7C0857521K 7C0857521F ♦ 7C0857521H	1
19.1013.012.099		211 x 169 x 19	7C0857522F ♦ 7C0857522K 7C0857522E ♦ 7C0857522H	1
19.1013.813.099		211 x 169 x 19	7C1857521D	2
19.1013.814.099		211 x 169 x 19	7C1857522D	2
61.1013.003.099		319 x 228 x 81	7C0898553	3
61.1013.002.099		319 x 228 x 81	7C0898554	3
13.1013.001.099		269 x 178 x 114	7C0857527	4
13.1013.002.099		269 x 178 x 114	7C0857528	4
13.1013.003.099		269 x 112 x 114	7C0857603A	5
13.1013.004.099		269 x 112 x 114	7C0857604A	5
08.1013.012.199		185 x 100 x 87	7C1949101B ♦ 7C1949101A	6
08.1013.013.199		185 x 100 x 87	7C1949102B ♦ 7C1949102A	6
08.1013.712.199		185 x 100 x 87	7C2949101B ♦ 7C2949101A	6
08.1013.713.199		185 x 100 x 87	7C2949102B ♦ 7C2949102A	6
08.1013.010.099		94 x 94 x 38	7C0959578	7
61.1013.001.099		94 x 94 x 38	2E0857049	8
61.1013.005.099		94 x 94 x 38	7C0898011	9



UNIVERSAL

*Agriculture
Case New Holland, Fendt,
John Deere, Kässbohrer, KFB etc.*



* Variante mit 2 Steckern für beheizbare Zusatzspiegel
version with 2 plug sockets for mounting additional heated mirrors

385		II e1 02★0469 I (E1) 010469		Truck II	ABS	① Ø 14-20 mm ② Ø 20-30 mm
MEKRA LANG Group		Beschreibung description descripção descripção benämning popis omicaawe üzellik leirás opis		mm		OE
51.3850.127H		314 x 228 x 65	G 297.810.150.030 (Fendt) AL158964 (John Deere)			
51.3850.227		314 x 228 x 65	00437650 (Case New Holland)			
40.2890.222H		300 x 214 x 3	F 297 810 150 010 (Fendt)			
51.3850.137		314 x 228 x 65				
40.2890.322		300 x 214 x 3				
10.6211.100		282 x 162				
09.2000.301H		2000 x 9 ø				
51.3850.147H		314 x 228 x 65	Y07001023 (KFB) HJ24013370 (VDL)			
51.3850.247		314 x 228 x 65	8.688.100.000.0 (Kässbohrer)			
40.2890.422H		300 x 214 x 3				
10.6221.100		282 x 162				
09.2000.301H		2000 x 9 ø				
51.3850.157		314 x 228 x 65				
40.2890.322		300 x 214 x 3				
10.6211.100		282 x 162				
51.3850.167H		314 x 228 x 65	D072143 (Bredamenarini)			
51.3850.197H *		314 x 228 x 65	2097 0652 (Volvo)			
51.3850.267		314 x 228 x 65	33.63730-6001 (MAN) D072143 (Bredamenarini)			
40.2890.422H		300 x 214 x 3				
10.6221.100		282 x 162	001 821 00 29 (Mercedes) 8.688.041.029.0 (Setra) 1905 564 00 (Neoplan) 161.00.77.2027 (MAN Steyr)			
09.3400.420		2000				

universal Rampenspiegel

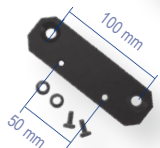

552-1		V VI e1 03★0033 V VI (E1) 020894		Truck V	ABS	
MEKRA LANG Group		Beschreibung description descripção descripção benämning popis omicaawe üzellik leirás opis		mm		OE
59.5520.530H		319 x 187 x 77	1525 537 (DAF) 105137C (Plaxton)			

UNIVERSAL

300				① Ø 30 mm ② Ø 35 mm
	Beschreibung description descripção descripção description benámening popis описання őzellik leírás opis			
55.3000.005.001			Ø 306 x 96	
51.3000.003.001			Ø 306 x 96	
51.3000.002.001			Ø 306 x 88	2401 8790 (Volvo) 3070159 (SCANIA)
61.3000.003.010			47 x 48 x 260	
61.3000.004.010			47 x 48 x 260	2401 8822 (Volvo) 3070160 (SCANIA)

Innenspiegel Busse
EvoBus, Göppel, Hess, Neoplan,
Scania, VDL, Volvo



750				INTEGR.
	Beschreibung description descripção descripção description benámening popis описання őzellik leírás opis			
51.7504.044.001			301 x 141	2320 0690 (Volvo)
20.7504.044.001			230	2328 6290 (Volvo)
20.7504.003.001			71	2328 6294 (Volvo)

Innenspiegel



552-1	V VI 03★0033 V VI 020894			INTEGR.
	Beschreibung description descripção descripção description benámening popis описання őzellik leírás opis			
59.5524.530H			418 x 492 x 77	27230912 (Terex)
51.5524.930H			316 x 186 x 77	

universal Frontspiegel



389	VI 03★0016 VI 020937			INTEGR.
	Beschreibung description descripção descripção description benámening popis описання őzellik leírás opis			
59.3891.140H			397 x 557 x 92	
51.3894.140H			Ø 259 x 92	



Montagevarianten
mounting possibilities
possibilités de montage
possibilidades de montagem
variante del montaggio
possibilidades de montaje
monteringsmøjligheter
Montážni varianty
Виды монтажа
montaj montaj olasılikları
különböző kivitelek
Możliwości montażu

A Dach
roof
pavillon
teto
tetto
techo
tak
střecha automobilu
Крышы автомобиля
kabin üstü
tetöre szerelt
Dach

B A-Säule
A-pillar
montant
pilar
A
pilastro
A
pilar A
A - stolpe
A - sloupek
A - obr. stölp
A - sütunu
A oszlopra szerelt
Stüpek

diverse Traktoren / various tractors



passend für • fitting for • approprié pour • para • adatto per • para • passar • vhodné pro • подходит для • kullanylabilinir • alkalmas • pasuje do

UNIVERSAL AGRICULTURE

152 ASKB	II 14010			Ø 10 / 12 / 13 mm
	Beschreibung description description descriçãõ descriçãõ benámenning popis omrcaavve özelliik leirás opsis			
51.1524.119H		260 x 149 x 22	E 178.810.150.019 (Fendt) E 178.810.150.010 (Fendt) F 178.810.150.020 (Fendt) 000 811 68 33 (Mercedes) 639 153 (Scania)	
40.1525.114H		252 x 141 x 3		

*Steyr Trucks
Steyr- + KHD Traktoren*



289				Ø 16-18 mm
	Beschreibung description description descriçãõ descriçãõ benámenning popis omrcaavve özelliik leirás opsis			
51.2890.117H		310 x 220 x 25	G 816.810.150.030 (Fendt) 161 0077 0103 (MAN Steyr) 81.63730-6170 (MAN)	
40.2890.222H		300 x 214 x 3	F 297 810 150 010 (Fendt)	
51.2890.147H		310 x 220 x 25		
40.2890.422H		300 x 214 x 3		
10.6221.100		282 x 162		
09.2070.101H		2070 x 9 Ø	10342167 (Liebherr) 11182172 (Liebherr)	

DEMAG, Caterpillar



363	II 03★0022 II 020905			Ø 18-28 mm
	Beschreibung description description descriçãõ descriçãõ benámenning popis omrcaavve özelliik leirás opsis			
51.3635.201		384 x 205 x 120	290-5544 (Caterpillar) 319-6789 (Caterpillar) 270011780 (Krone)	
51.3636.201		384 x 205 x 120	290-5545 (Caterpillar) 319-6788 (Caterpillar)	
51.3635.204		384 x 205 x 120	294-1991 (Caterpillar) 316-6791 (Caterpillar)	
51.3636.204		384 x 205 x 120	294-1992 (Caterpillar) 319-6790 (Caterpillar)	
15.3802.840H		368 x 189 x 40	8.688.105.263.0 (Kässbohrer) 11312890 (Krauss-Maffei) 10470601 (Liebherr) AP105367C-3 (Plaxton) 990115703000 (Tatra) 48092012 (Terex)	
51.3635.206		384 x 205 x 120	688 645 (Fritzmeier) 8.688.105.000.0 (Kässbohrer) 443332051000 (Tatra)	
51.3636.206		384 x 205 x 120	688 646 (Fritzmeier) 8.688.106.000.0 (Kässbohrer) 443332052000 (Tatra)	
15.3802.840H		368 x 189 x 40	<i>siehe oben / see above</i>	
11.3730.210H		367 x 187 x 60	84434473 (CNH)	

UNIVERSAL AGRICULTURE

1038	NEW	II (E1) 051696			Ø 22 mm
-------------	------------	----------------	--	--	---------

		Beschreibung description description descripção descripzione benamining pops onivcauwe bireilik leirats opts		OE
51.1038.003.099			359 x 178 x 89	
51.1038.004.099			359 x 178 x 89	
58.1038.003.099		PP	554 - 804 Teleskop	30331340 (Claas)
58.1038.004.099		PP	554 - 804 Teleskop	30331350 (Claas)
58.1038.147.099		PP	554 - 804 Teleskop	29741800 (Claas)
58.1038.247.099		PP	554 - 804 Teleskop	29741810 (Claas)
40.1038.411.099			234 x 166 x 2	a
40.1038.412.099			234 x 166 x 2	
40.1038.751.099			162 x 125 x 2	b
40.1038.752.099			162 x 125 x 2	

Werkzeuglos verstellbar von vertikal zu horizontal
Adjustable from vertical to horizontal without tools



1010		II (E1) 021228			Ø 14 - 20 mm
-------------	--	----------------	--	--	--------------

		Beschreibung description description descripção descripzione benamining pops onivcauwe bireilik leirats opts		OE
51.1010.010.001			284 x 176 x 90	R561145311 (Kubota)
40.1010.002.099			278 x 169 x 2	

Kleine Traktoren
small tractors



UNIVERSAL AGRICULTURE

1009

II (E1) 021165



Ø 18-22 mm
Ø 28 mm *



Beschreibung
description
description
description
benamning
pops
omrcauwe
üzellik
opis



Große Traktoren
large tractors

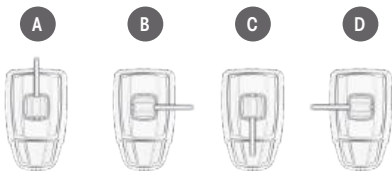

Rohranbindung
mounting position arm



1
Haupt- und Nahbereichsiegel
Main and close proximity mirror



2
Hauptspiegel mit großen
Nahbereichsspiegel für
Traktoren ISO 5721-2
Main - and large close proximity
mirror for tractors ISO 5721-2



3
Hauptspiegel mit großen
Nahbereichsspiegel für
Radbagger ISO14401-2
Main - and large close proximity
mirror for Wheel excavator
ISO14401-2

1				
51.1009.017.099		382 x 232 x 122	372-8075 (Caterpillar) 26143870 (Class) G304810150020 (Fendt) ACV0805960 (Fendt/Valtra) 42154H3480 (Komatsu) 21D-54-41710 (Komatsu) 1000386860 (Kramer) 11068341 (Liebherr) 3010662 (Lindner) 17452496 (Volvo)	
51.1009.027.099		382 x 232 x 122	436-2886 (Caterpillar)	
51.1009.149.099		382 x 232 x 122	1000390196 (Kramer) 11181691 (Liebherr) 21971360 (Claas)	
51.1009.097.099		382 x 232 x 122	1000396281 (Kramer) ACV0148490 (Valtra) 3728076-03 (Carwall)	
51.1009.025.099		382 x 232 x 122	ACV0148490 (Fendt) 42154H3380 (Komatsu) 16281990 (Volvo)	
51.1009.045.001		382 x 232 x 122		
51.1009.047.001		382 x 232 x 122		
51.1009.246.099		382 x 232 x 122	372-8076 (Caterpillar)	
2				
51.1009.021.099		465 x 231 x 143	26095630 (Claas) G743810150010 (Fendt) 3010850 (Lindner)	
51.1009.022.099		465 x 231 x 143	G743810150020 (Fendt) 26096000 (Claas) 1000379630 (Kramer) 3010851 (Lindner)	
51.1009.121.099		465 x 231 x 143	3010852 (Lindner)	
51.1009.122.099		465 x 231 x 143	1000379641 (Kramer) 3010853 (Lindner)	
51.1009.123.099		465 x 231 x 143		
51.1009.124.099		465 x 231 x 143		
3				
51.1009.242.099		Ø 28 mm	436-2887 (Caterpillar)	

UNIVERSAL AGRICULTURE

1009	II (E1) 021165			Ø 18-22 mm Ø 28 mm *
-------------	----------------	--	--	-------------------------

Beschreibung description descripción descrizione benamining þóppas ошрцавање бреллик leírás opís

09.2000.301H		2000 x 9 Ø	11181692 (Liebherr)
09.3200.420H		42 x 42 x 54 [2000]	6.200.26.176 (Mauser)

51.1009.001.099		291 x 232 x 121	526-5057 (Caterpillar) 3010115 (Lindner) 2186303 (Wirtgen)	a
51.1009.081.099		291 x 232 x 121	3010188 (Lindner)	
51.1009.113.099		291 x 232 x 121	22332170 (Claas) AKK34593 (John Deere)	
51.1009.009.099		291 x 232 x 121	545541 (Miller)	
40.1009.001.000		285 x 225 x 2	5653634836 (Terex) F743810150010 (Fendt)	
40.1009.004.099		285 x 225 x 2	ACV0759270 (Fendt/ Valtra) 3205677 (Lindner)	
40.1009.001.099		285 x 225 x 2		
51.1009.049.099		190 x 109 x 18		b
51.1009.047.099		190 x 109 x 18		
51.1009.048.099		190 x 109 x 18		
40.1009.002.000		178 x 92 x 2	5653634837 (Terex) F304810150030 (Fendt)	a
40.1009.002.099		178 x 92 x 2	11578550 (Claas) ACV0759280 (Valtra)	
40.1009.005.099		178 x 92 x 2	166352077 (SIAC)	
61.1009.001.099		196 x 188 x 42	11654110 (Claas)	c
61.1009.002.099		196 x 188 x 42	11654120 (Claas)	
40.1009.421.002		180x 170 x 2	F743810150020 (Agco) 11653140 (Claas)	
40.1009.422.002		180x 170 x 2	F749810150030 (Agco) 11653170 (Claas)	
40.1009.431.099		180x 170 x 2		
40.1009.432.099		180x 170 x 2		
40.1009.433.099		180x 170 x 2		
40.1009.434.099		180x 170 x 2		
40.1009.003.099		202 x 138 x 3		d



UNIVERSAL AGRICULTURE

Teleskopstange
telescopic bracket

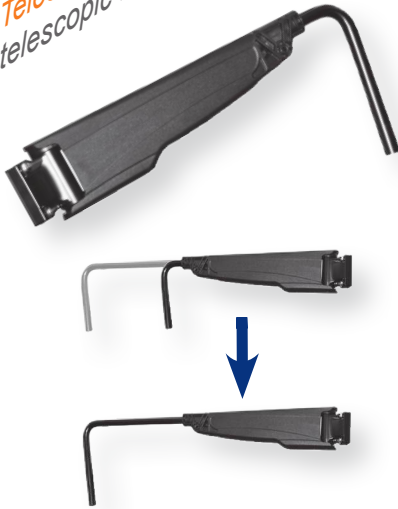

1017		st		Ø 22 mm
MEKRA LANG Group		mm		OE
Beschreibung description descrição descripzione benamning popis omicaune üzellik opis				
58.1017.005.099		510 - 800 Teleskop	G-530810150010 (AGCO)	
58.1017.006.099		510 - 800 Teleskop	G-530810150020 (AGCO)	
58.1017.013.099		510 - 800 Teleskop		
58.1017.014.099		510 - 800 Teleskop		
58.1017.011.099		510 - 800 Teleskop	3009961 (Lindner)	
58.1017.012.099		510 - 800 Teleskop	3009999 (Lindner)	
58.1017.015.099		510 - 760 Teleskop		
58.1017.016.099		510 - 760 Teleskop		

John Deere
6R Premium

2022 - 2026



Design Abdeckung ist im Lieferumfang nicht enthalten. Bezug über John Deere möglich.
Design cover is not included. Can be purchased from John Deere.

1036+1017		II (E1) 041459		II + IV Truck	ABS	Ø 22 mm
MEKRA LANG Group		mm		OE		
Beschreibung description descrição descripzione benamning popis omicaune üzellik opis						
1 51.1036.017.099		487 x 228 x 130	AL232743 (John Deere)			
51.1036.018.099		487 x 228 x 130	AL232744 (John Deere)			
2 61.1017.080.099		600-883 Teleskop	AL225722 (John Deere)			
61.1017.081.099		600-833 Teleskop	AL237885 (John Deere)			



Inkl. Befestigungskomponenten
Incl. mounting components

2

UNIVERSAL AGRICULTURE

1036	II (E1) 041459			Ø 22 mm
-------------	----------------	--	--	---------

	Beschreibung description description description benamining popsis описание birelik letras opis		OE
--	--	--	----

51.1036.021.099		487 x 228 x 130		1
51.1036.022.099		487 x 228 x 130		
51.1036.023.099		487 x 228 x 130	26079370 (Claas) 47826941 (CNH)	
51.1036.024.099		487 x 228 x 130	26079500 (Claas) 47904843 (CNH)	
51.1036.025.099		487 x 228 x 130	6-200.26.185 (Mauser)	
51.1036.026.099		487 x 228 x 130		
11.1036.011.099		153 x 144 x 45	11617700 (Claas) 51487075 (CNH) R566924 (John Deere)	
11.1036.012.099		153 x 144 x 45	11617720 (Claas) 51487076 (CNH)	
51.1036.007.099		487 x 228 x 130	47922743 (CNH)	2
51.1036.008.099		487 x 228 x 130	47922744 (CNH)	
51.1036.009.099		487 x 228 x 130	47922739 (CNH)	
51.1036.010.099		487 x 228 x 130	47922741 (CNH)	
11.1036.013.099		153 x 144 x 45	48025212 (CNH) L221136 (John Deere)	
11.1036.014.099		153 x 144 x 45	48025217 (CNH) L221137 (John Deere)	
19.1036.005.099		299 x 202 x 24	48025196 (CNH)	
19.1036.006.099		177 x 190 x 14	48025209 (CNH)	
19.1036.007.099		299 x 202 x 24	11617730 (Claas) 48025195 (CNH) AL225823 (John Deere)	
19.1036.008.099		177 x 190 x 14	11617740 (Claas) 48025204 (CNH) AL225824 (John Deere)	
19.1036.009.099		299 x 202 x 24		
19.1036.010.099		177 x 190 x 14		
09.3200.420H		42 x 42 x 54 [2000]		

Große Traktoren
large tractors



- 1** Vertikale Rohranbindung
Mounting to vertical tube
- 2** Horizontale Rohranbindung
Mounting to horizontal tube

UNIVERSAL MOTOR HOMES

BÜRSTNER Grand Panorama 2012
 CARTHAGO Chic 2012
 EURA MOBIL Integra 2012
 CONCORDE, Plaxton, Hymer

1018	II (E1) 021281 IV (E1) 021282			INTEGR.
-------------	----------------------------------	--	--	----------------

	Beschreibung description descripção descrizione benamining Popis omivcawne birelik leiraks opis		mm	
--	--	--	----	--

1	59.1018.003.099		673 x 245 x 327	284260 (Concorde)
	59.1018.004.099		673 x 245 x 327	284261 (Concorde)
	12.1018.003.099		182 x 64 x 61	
2	59.1018.007.099		699 x 245 x 406	2276379 (Bürstner)
	59.1018.008.099		699 x 245 x 406	207193 (Carthago)
	12.1018.005.099		262 x 64 x 64	
3	59.1018.001.099		727 x 245 x 480	200070726B (Eura Mobil)
	59.1018.002.099		727 x 245 x 480	200070727B (Eura Mobil)
	12.1018.007.099		345 x 64 x 67	2193841 (Bürstner) 201621 / 201622 (Carthago)
	12.1018.001.099		517 x 197 x 70	2193829 (Bürstner) 201619 (Carthago) 2203 3845 (Volvo)
	12.1018.002.099		517 x 197 x 70	2193831 (Bürstner) 201620 (Carthago) 2203 3846 (Volvo)
	15.2780.841F		307 x 177 x 22	8034580 (Hymer)
	19.1018.311.099		178 x 142 x 34	
	19.1018.312.099		178 x 142 x 34	
	12.1018.009.001		226 x 116 x 85	2193839 (Bürstner) 284265 (Concorde) 207195 (Carthago) 175202B-9 (Plaxton)
	12.1018.010.001		226 x 116 x 85	2193840 (Bürstner) 284266 (Concorde) 207196 (Carthago) 175202B-8 (Plaxton)
	09.2910.005.099		3550 x 6 ø	2218519 (Bürstner) 200070749 (Eura Mobil)
	09.2910.002.099		6050 x 6 ø	2218516 (Bürstner) 200070751 (Eura Mobil) 2203 8103 (Volvo)
	08.3200.233H		42 x 42 x 54	200607013 (Bürstner) 112228 (Carthago) 200070818 (Eura Mobil) 1449696 (Hymer) 2092 5244 (Volvo)



a Haltefußabdeckung
cover retaining foot



b Tragarmschale oben
up cover support shaft



c Spiegelkopfabdeckung
mirror head cover

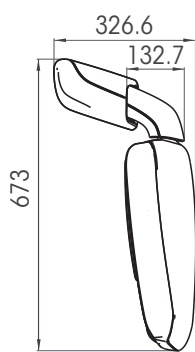

kurz short **1**

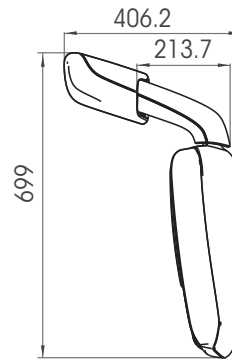

mittel middle **2**

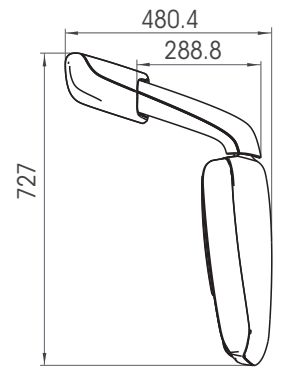

lang long **3**

UNIVERSAL COACHES

271		II e1 02★0524 II (E1) 010524		Truck II ABS PU		A	
MEKRA LANG Group		Beschreibung description description description benamining pops описание leirats opis		mm		OE	
59.2710.401H		703 x 783 x 212	284230 (Concorde) 53-707213-710401 (Merkavim) AA-01976 (Plaxton) P758200126 (VDL) 8350 042502 * 7032 8278 (Volvo)	1			
51.3731.326		384 x 205 x 116	50.06.232.483 (Irisbus) 17294289-0 (Marcopolo) 53-707127-731326 (Merkavim) PAA-01976-1 (Plaxton) 189 3532 (Scania) 1905 503 00 (Solaris) 30022423 (VDL) 7030 9627 * 8706 2719 00059 (Volvo) 8350 035653 (Volvo)	2			
59.2710.402H		701 x 641 x 200	1251 2071 (Carrus) 284232 (Concorde) 53-707213-710402 (Merkavim) 30017729 (VDL) 7302 8283 (Volvo)	3			
51.3732.326		384 x 205 x 116	D072145 (Bredamenarini) 7036 9682 (Carrus) 50.06.232.482 (Irisbus) 17294289-0 (Marcopolo) PAA-01977-1 (Plaxton) 180 5203 * 189 5048 (Scania) 1905-502-00 (Solaris) 8706 2719 00060 (Volvo) 8350 035654 (Volvo)	4			
59.2710.454		701 x 801 x 200	083895B (Plaxton)	3			
51.3731.326		384 x 205 x 116	siehe oben / see above	3			
59.2710.406		701 x 746 x 200	284233 (Concorde) AA-01977 (Plaxton)	4			
51.3732.326		384 x 205 x 116	siehe oben / see above	4			
15.3731.470H		368 x 189 x 40	284248 (Concorde) 425 562 28 (Iveco) PAA-01976-2 (Plaxton) 150 5201 (Scania) 1905 731 470 (Solaris) 30017741 (VDL) 8706 2719 00030 (Volvo)	a			
15.2711.114		165 x 93 x 25	284226 (Concorde) 42545988 (Irisbus) 001 810 60 16 (Mercedes) PAA-01976-3 (Plaxton) 8355 0046556 (Volvo)	b			
15.2712.114		152 x 128 x 23	284228 (Concorde) 42545989 (Irisbus) 001 810 61 16 (Mercedes) PAA-01977-4 (Plaxton) 8350 046557 (Volvo)	c			
15.2712.113F		152 x 128 x 23	7030 60536 (Volvo)	d			
11.3730.210H		367 x 187 x 60	84434473 (CNH) 425 459 90 * 425 562 27 (Iveco) 150 5202 (Scania) 17294287-7 (Marcopolo) 8706 2719 00052 (Volvo) 1905 770 210 (Solaris)				
20.2700.200H		126 x 25 Ø	1299452 (Hymer)				
20.2710.200H*		183 x 181 x 84	17294281 (Marcopolo) AA-01978 * AA-01979 (Plaxton) 7036 0530 * 8350 046433 (Volvo)				
20.2710.111H		183 x 145 x 107	09-37986101-8 (Marcopolo) 8706 2719 00020 (Volvo) 8350 046970 (Volvo)				
20.2710.121		183 x 145 x 107	09-37986101-8 (Marcopolo) 7032 8290 * 033 1121 (Volvo)				
20.2480.213		108 x 50 x 15 [800]	356 810 06 11 (Mercedes) AA-01980 * AA-01981 (Plaxton)				
20.2480.216H		108 x 50 x 15 [2000]	284240 (Concorde) 83.63731-6507 (MAN) 53-750610-208091 (Merkavim) 145 1226 (Scania) 1970-018-000 (Solaris) P759001645 (VDL) 7033 1124 * 8350 046971 (Volvo)				
20.2480.217H		108 x 50 x 15 [5000]	284242 (Concorde) 425 459 85 (Iveco) 81.63731-6470 (MAN) P107424C-10 (Plaxton) 53-707213-480217 (Merkavim) P759001646 (VDL) 7033 1123 7034 8002 (Volvo) 8706 2719 00018 (Volvo) 8350 046432 (Volvo)				

Reisebusse / Coaches:
 Avtobus, BMC, Concorde, Dallavia,
 EvoBus, Euro Coach, Hymer,
 Ikarbus, Irisbus, Marcopolo, MAZ,
 LAZ, Plaxton, TEMSA, Tovarna,
 VDL, Volvo (7500 DD, 7700, 8700,
 City Bus, 9300, 9700, Interregio),
 Wrightbus



* für für pour 59.2710.406
 2 pieces necessary

UNIVERSAL COACHES

291	II (E1) 021203			INTEGR.
	IV (E1) 021207			

	Beschreibung description descrição descripción benámenning popis ömrcauwe ბრწილი opis		OE
--	---	--	-----------

CAETANOBUS Cobus 3000
 CONCORDE Charisma III
 HESS
 MAN Lion's City
 PLAXTON Panther
 PLAXTON Elite
 PLAXTON R9700
 RUNIRAN Safari
 TEMSA Safir
 TEMSA MD 9
 VISEON C-Serie
 Volvo 9700 / 9900
 VDL Futura

01/2012
 08/2012
 01/2011
 10/2012
 2011
 10/2010
 05/2011
 06/2011
 10/2011



1
Spiegel mit HS, WWS
mirror with HS, WWS



2
Spiegel mit HS und Bugspiegel
mirror with HS and front crossview mirror

1	59.2910.001.001		1196 x 696 x 239	284215 (Concorde) 5053-APA-06Y (TEMSA) 44.17604-0317 (Viseon) 2187 9369 (Volvo)
	59.2910.002.001		1196 x 696 x 239	284216 (Concorde) 5053-APA-04Y (TEMSA) 44.17604-0318 (Viseon) 2189 4545 (Volvo)
	59.2910.019.001		1196 x 696 x 239	203722 (Carthago)
	59.2910.020.001		1196 x 696 x 239	203723 (Carthago)
	59.2910.009.001		1196 x 696 x 239	AP140857C-1 (Plaxton)
	59.2910.010.001		1196 x 696 x 239	AP119170C-2 (Plaxton) MD301145Y (TEMSA)
	59.2910.005.001		1196 x 696 x 239	2202 6968 (Carrus)
	59.2910.006.001		1196 x 696 x 239	
	59.2910.015.001		1196 x 696 x 239	22360737 (Volvo)
	59.2910.016.001		1196 x 696 x 239	22360738 (Volvo)
2	59.2910.003.001		1196 x 696 x 239	AP119170C-100 (Plaxton) 44.17604-0321 (Viseon) HD301144Y (TEMSA)
	59.2910.004.001		1196 x 696 x 239	44.17604-0322 (Viseon) 2187 9404 (Volvo)
	59.2910.017.001		1196 x 696 x 239	158388C (Plaxton)
	59.2910.018.001		1196 x 696 x 239	158396C (Plaxton)
3	59.2910.007.001		1196 x 696 x 239	
	59.2910.008.001		1196 x 696 x 239	2202 6977 (Volvo)
4	59.2910.013.001		1196 x 696 x 239	248268 (Concorde)
	59.2910.014.001		1196 x 696 x 239	248269 (Concorde)



3
Spiegel mit HS, WWS und ZS (links)
mirror with HS, WWS and ZS (left)



4
Spiegel mit HS, WWS und NBS (rechts)
mirror with HS, WWS and NBS (right)

UNIVERSAL COACHES

291	II (E1) 021203 IV (E1) 021207			INTEGR.
	Beschreibung description description description benamning popsis описание breylik leirás opis			
61.2910.001.001		262 x 150		3
61.2910.002.001		262 x 150	22117455 (Volvo)	
61.2910.003.001		312 x 150	5053-APA-05Y (Temsas)	4
61.2910.004.001		312 x 150	5053-APA-03Y (Temsas)	
61.2910.005.001		412 x 150	HD 301152 (Temsas)	5
61.2910.006.001		412 x 150	HD 301151 (Temsas)	
61.2910.021.001		412 x 150	284217 (Concorde)	
61.2910.022.001		412 x 150	284218 (Concorde)	
09.2910.007.000		1050 x 6 ø		
09.2910.004.099		2750 x 6 ø	201931 (Carthago)	
09.2910.005.099		3550 x 6 ø	2218519 (Bürstner) 200070749 (Eura Mobil)	
09.2910.002.099		6050 x 6 ø	2218516 (Bürstner) 284221 (Concorde) 200070751 (Eura Mobil) 44.15240-0300 (Viseon) 2203 8103 (Volvo)	
09.2910.003.099		6050 x 6 ø	22212554 (Volvo)	
09.2770.001.000		6050 x 6 ø		
08.3200.233H		42 x 42 x 54	20925244 (Volvo)	

CAETANOBUS Cobus 3000 01/2012
 CONCORDE Charisma III 08/2012
 HESS
 MAN Lion's City
 PLAXTON Panther
 PLAXTON Elite
 RUNIRAN R9700
 TEMSA Safari
 TEMSA Safir
 TEMSA MD 9
 VISEON C-Serie
 Volvo 9700 / 9900
 VDL Futura

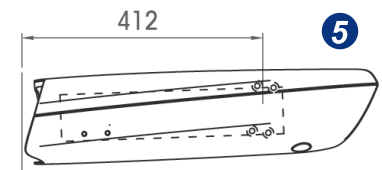
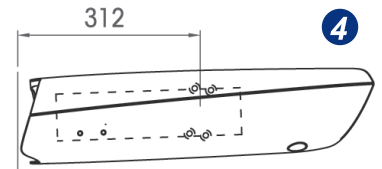
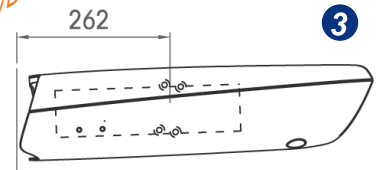

15.2780.840		307 x 177 x 22	81.63733-0113 (MAN) P119170C-8 (Plaxton) 5053-APA-04-01Y (TEMSA) 30017846 (VDL) 48.17600-0026 (Viseon)
15.2780.841F		307 x 177 x 22	201932 (Carthago)
19.2910.001.099		184 x 154 x 31	P119170C-7 (Plaxton) 5053-APA-04-03Y (TEMSA)
19.2910.002.099		184 x 172 x 39	HD301144-02Y (TEMSA)
08.3950.001.099	Control Unit for	40 x 30 x 30	22038110 (Volvo)
08.2910.001.002	LED		22488075 (Volvo)
61.5590.001.099		256 x 165 x 82	
61.2910.011.002		509 x 112 x 123	22117205 (Volvo) 30130982 (VDL)
61.2910.012.002		509 x 112 x 123	22117220 (Volvo) 30130983 (VDL)
11.2910.001.000		597 x 105 x 66	
11.2910.002.000		617 x 112 x 105	
11.2910.003.000		651 x 112 x 146	
11.2910.006.000		597 x 105 x 66	
11.2910.007.000		617 x 112 x 105	
11.2910.008.000		651 x 112 x 146	
11.2910.011.002		514 x 225 x 121	
11.2910.012.002		514 x 225 x 121	

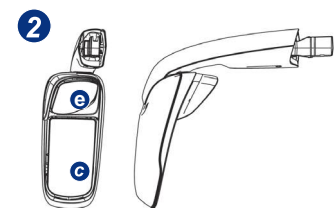
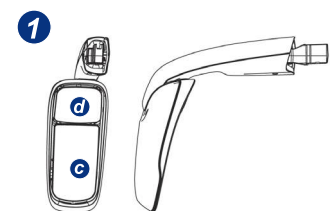

Heizkabel mit Steckanschluss
Heating cable with plug



Steuerkabel
control cable



UNIVERSAL ELECTRONICS

		Beschreibung description descripción descrizione description benämning popis omscavne őzellék leírás opis		
09.2070.101H			2070 x 9 ø	
09.2000.301H			2000 x 9 ø	









		Beschreibung description descripción descrizione description benämning popis omscavne őzellék leírás opis		
09.3200.320H			2000 x 6 ø	
09.3300.421			2000 x 6 ø	

		Beschreibung description descripción descrizione description benämning popis omscavne őzellék leírás opis		
08.3200.233H			42 x 42 x 54	

		Beschreibung description descripción descrizione description benämning popis omscavne őzellék leírás opis		
09.3200.420H			42 x 42 x 54 [2000]	
08.3200.233H			42 x 42 x 54	
09.3200.220			1000	
09.3200.320H			2000 x 6 ø	
09.3400.420			42 x 42 x 54 [2000]	
08.3200.233H			42 x 42 x 54	
09.3200.220			1000	
09.3200.320H			2000	
09.3300.421			2000	

UNIVERSAL ACCESSORIES

248/2 A

		Beschreibung description description description description benámení popis описание özellik opis	 mm	
20.2480.210H			108 x 50 x 15	5571298 (Bomag) D067504 (Bredamenarini) 218 142 (Fritzmeier) 84433427 (Case New Holland) 7621216 (Liebherr) 17294377-6 (Marcopolo) 671 811 0111 (Mercedes) P105367C-15 (Plaxton) 144 8217 (Scania) 7035 2646 (Volvo) 8706 2719 00055 (Volvo)
20.2480.211H			108 x 50 x 15 [2500]	145 1227 (Scania) 1990-685-650 (Solaris) 2085 4088 (Volvo) 8350 003620 (Volvo)
20.2480.223			108 x 50 x 15 [150]	81.63731-6478 (MAN) 17294378-2 (Marcopolo) 2051 5454 (Volvo) 8706 2719 00040 (Volvo)
20.2480.213			108 x 50 x 15 [800]	356 810 06 11 (Mercedes) AA-01980 / AA-01981 (Plaxton)
20.2480.216H			108 x 50 x 15 [2000]	284240 (Concorde) VI-10-01-010 (Eura Mobil) R21640 (Lahden) 83.63731-6507 (MAN) 53-750610-208091 (Merkavim) 145 1226 (Scania) 1970-018-000 (Solaris) P759001645 (VDL) 7033 1124 / 8350 046971 (Volvo) 284242 (Concorde) 425 45985 (Iveco) 77037873 (Komatsu)
20.2480.217H			108 x 50 x 15 [5000]	R21645 (Lahden) 81.63731-6470 (MAN) 53-707213-480217 (Merkavim) P107424C-10 (Plaxton) P759001646 (VDL) 7033 1123 / 7034 8002 (Volvo) 8350 046432 / 8706 2719 00018 (Volvo)

Aufsteckkeile
Mounting wedges

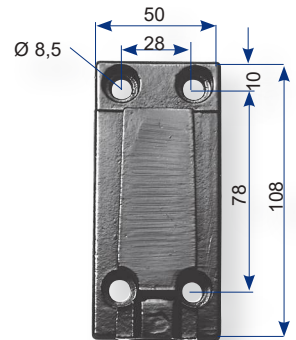

271 A

		Beschreibung description description description description benámení popis описание özellik opis	 mm	
20.2710.620			124 x 59 x 21 [5000]	200083489 (Eura Mobil) 50.00.021.163 (Irisbus) 17042340N0000 (Krauss-Maffei) 53-707213-710620 (Merkavim) 7033 1941 (Volvo)

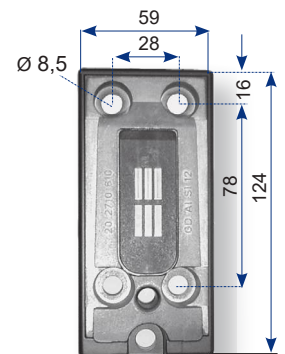

UNIVERSAL AGRICULTURE

1016



Ø 22 mm

MEKRA
LANG Group

Beschreibung
description
descrição
descriptione
description
benämning
pops
omicaue
üzeylik
opis



OE

Haltestangen brackets

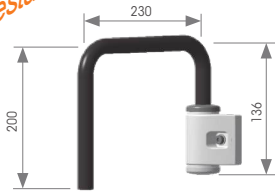

U-Form
U-shape

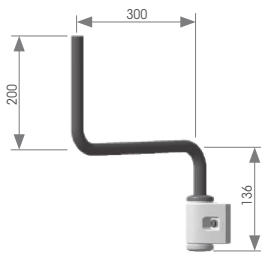

Z-Form
Z-shape

U	58.1016.001.099		200 x 230 x 136
	58.1016.002.099		200 x 230 x 136
	58.1016.003.099		200 x 230 x 136
	58.1016.004.099		200 x 230 x 136
Z	58.1016.005.099		336 x 300
	58.1016.006.099		336 x 300
	20.1016.004.000	Sechskant hex attachment for	

Manuell verstellbar in 30°-Stufen

Manually adjustable in steps of 30°

Montage von Innenseite Fahrzeug verschraubt (Variante 2) oder von außen mittels Sechskant verschweißt (Variante 1) möglich

Mounting base bolted through hex attachment (Version 1) or directly bolted from vehicle side (Version 2)

Sowohl hängend als auch stehend montierbar (Darstellung: stehend)

Tube can be turned upside down hanging and standing (Shown: standing)

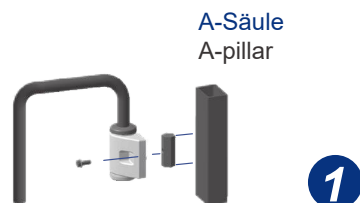
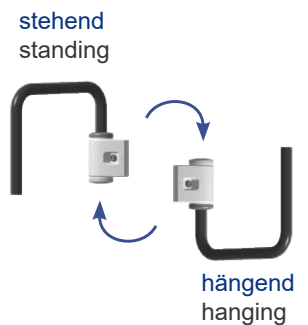

Montage von Außenseite Fahrzeug verschweißt
Mounting base bolted through hex attachment

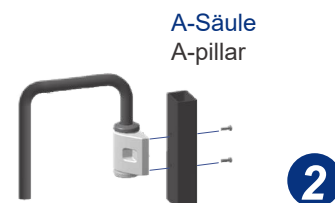

Montage von Innenseite Fahrzeug verschraubt
Mounting directly bolted from vehicle side

UNIVERSAL BUSES

270 A				st		Ø 28 mm	
MEKRA LANG Group		Beschreibung description description description benamining pops описание brailis opis		mm		OE	
58.2704.051H			90°	270 x 464 x 28 ø	0783032 (Dethleffs) 1905-509-025 (Solaris)	1	
58.2704.048			90°	216 x 514 x 28 ø	HEO 627 810 M1 47 (EvoBus) 3600100512654 (Evobus) 1905-508-000 (Solaris) 0000-217-083 (Solaris) 7032 8298 (Volvo) 7033 1060 (Volvo) 2053 5857 (Volvo)	2	
58.2704.044			90°	216 x 514 x 28 ø	7032 8298 (Volvo) 2053 5857 (Volvo)		
58.2704.088			120°	216 x 514 x 28 ø	50.06.232.165 (Irisbus)		
58.2704.070			6°	732 x 327 x 28 ø	1905-509-000 (Solaris) 7032 8294 (Volvo)	3	
58.2704.086			6°	732 x 327 x 28 ø	1905 500 010 (Solaris) 2056 4284 (Volvo)		
58.2704.093			6°	732 x 327 x 28 ø	1905-506-010 (Solaris)		
58.2705.003			17°	668 x 350 x 28 ø	7035 2000 (Volvo)	4	
58.2705.001H			17°	668 x 350 x 28 ø	7030 9620 (Volvo) 8706 2719 00056 (Volvo) VG10037.000 (Volvo)		
61.2708.842H					150 5203 (Scania)		
61.2703.110			128°	156 x 129 x 36	000 810 04 12 (Mercedes)		
61.2703.120			56°	156 x 129 x 36	000 810 05 12 (Mercedes)		

Haltestangen brackets

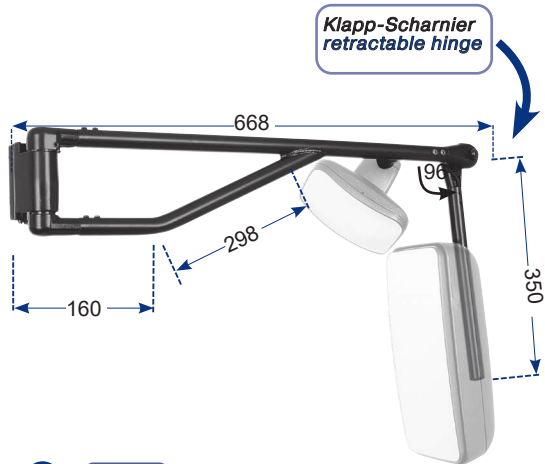
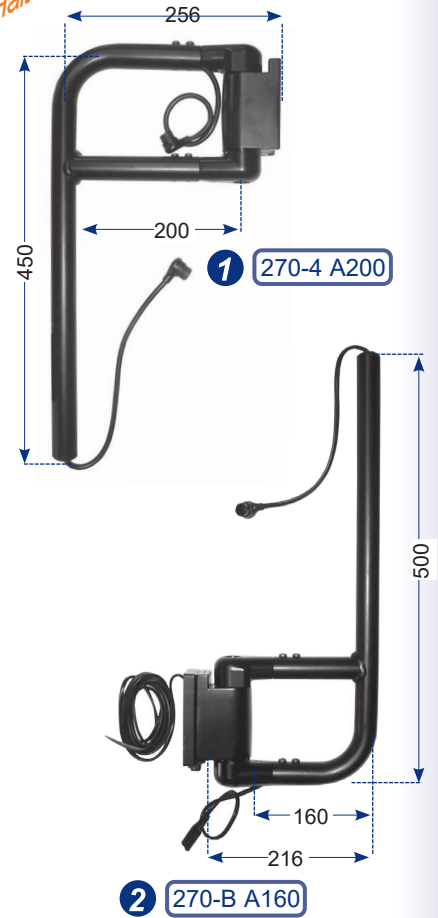

4 270-5

Klappstange
hinged tube

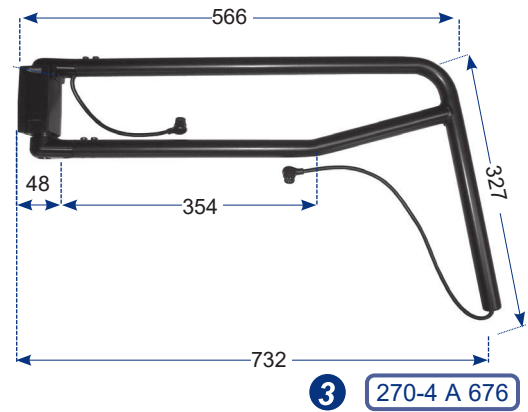

3 270-4 A 676



UNIVERSAL

UNIVERSAL

ALLGEMEINE GESCHÄFTSBEDINGUNGEN (AGB)

I. Allgemeine Bedingungen

Den Vertragsbeziehungen zwischen uns, MEKRA Lang GmbH & Co. KG („MEKRA Lang“), und unseren Bestellern, die Unternehmer im Sinne des § 14 BGB sind, liegen ausschließlich die nachfolgenden AGB zugrunde. Abweichende Geschäftsbedingungen des Bestellers werden, selbst bei Kenntnis, nicht Vertragsbestandteil. Unsere Angebote sind stets freibleibend. Unsere AGB gelten mit der Auftragserteilung, spätestens mit der Annahme der Ware als anerkannt. Diese AGB gelten bei ständigen Geschäftsbeziehungen auch für alle künftigen Geschäfte. Sollten einzelne Bestimmungen ganz oder teilweise unwirksam sein oder werden, so wird hierdurch die Gültigkeit der übrigen Bestimmungen nicht berührt. In diesem Fall werden MEKRA Lang und der Besteller eine Regelung vereinbaren, deren wirtschaftlicher Erfolg dem der unwirksamen Regelung möglichst nahe kommt. Bis dahin gilt die Gesetzregelung.

II. Vertragsschluss und Preise

- Mit der Bestellung einer Ware erklärt der Besteller verbindlich, die bestellte Ware erwerben zu wollen. Er ist an diese Erklärung zwei Wochen gebunden. Wir sind berechtigt, das in der Bestellung liegende Vertragsangebot innerhalb von zwei Wochen nach Eingang bei uns anzunehmen. Die Annahme kann schriftlich, elektronisch oder durch Auslieferung der Ware an den Besteller erklärt werden.
- Die Verpflichtungen im elektronischen Geschäftsverkehr gem. § 312a Abs. 1 Satz 1 Nr. 1 bis 3 und Satz 2 BGB werden ausgeschlossen.
- Der Vertragsschluss erfolgt unter dem Vorbehalt der richtigen und rechtzeitigen Selbstbelieferung durch unsere Zulieferer. Dies gilt nur für den Fall, dass die Nichtbelieferung nicht von uns zu vertreten ist, insbesondere bei Abschluss eines kongruenten Deckungsgeschäftes mit unseren Zulieferern. Der Besteller wird über die Nichtverfügbarkeit der Leistung unverzüglich informiert und die Gegenleistung, soweit bereits geleistet, unverzüglich zurückerstattet.
- Alle vertraglichen Zahlungsverpflichtungen sind ausschließlich in EURO zu erfüllen.
- Die Preise verstehen sich netto ab Werk bzw. Auslieferungslager (gemäß Incoterms 2020). Fracht-, Verpackungs-, Einfuhrkosten, Zoll und sonstige Nebenabgaben gehen zu Lasten des Bestellers.

III. Lieferzeit und Lieferverpflichtung

- Für Umfang, Art und Zeitpunkt der Lieferung ist unsere schriftliche oder elektronische Auftragsbestätigung maßgebend. Teil-Lieferungen sind zulässig.
- Eine Verpflichtung zur Einhaltung als verbindlich bezeichneter Lieferfristen wird nur unter der Voraussetzung eines ungestörten Betriebs- und Vertriebsablaufs übernommen; insbesondere in Fällen höherer Gewalt und sonstiger störender Ereignisse bei uns, bei unseren Lieferanten oder bei den Transportunternehmern, beispielsweise Betriebs- oder Verkehrsstörungen, Feuer, Überschwemmungen, Arbeitskräfte-, Energie- oder Verkehrsmangel, Streik, Aussperrung, behördliche Maßnahmen sowie technische oder technologische Umstände, welche die Auftragsausführung wesentlich erschweren, entbinden uns von der Pflicht zur rechtzeitigen Lieferung oder geben uns das Recht, unsere Lieferung ohne Nachlieferpflicht einzustellen.
- Sofern nichts Abweichendes vereinbart ist, sind wir berechtigt, bereits vor einem genannten Liefertermin zu leisten. Ebenso gilt, sofern nichts Abweichendes vereinbart ist, eine bis maximal zwei Wochen über einem genannten Liefertermin liegende Leistung unsererits nicht als verspätet.
- Lieferfristen gelten als eingehalten, wenn bis zu ihrem Ablauf die Ware das Werk oder Auslieferungslager verlassen hat oder dem Besteller die Anzeige unserer Versandbereitschaft zugegangen ist. Nachträgliche Änderungen des Vertrages verlängern die Lieferfristen angemessen.
- Bei Verträgen, deren Erfüllung aus mehreren Lieferungen besteht, ist Nichterfüllung, oder mangelhafte oder verspätete Erfüllung einer Lieferung ohne Einfluss auf andere Lieferungen aus dem Vertrag.
- Zahlungsverzug, die Abgabe einer eidesstattlichen Offenbarungsversicherung gemäß § 807 ZPO, eintretende Zahlungsschwierigkeiten oder das Bekanntwerden einer wesentlichen Verschlechterung der Vermögensverhältnisse des Bestellers berechtigen uns nach unserer Wahl, für noch offenstehende Lieferungen Vorauszahlung zu verlangen oder Lieferungen sofort einzustellen und die Erfüllung laufender Verträge zu verweigern. Gleichzeitig sind wir berechtigt, noch nicht fällige Forderungen gegen den Besteller sofort fällig zu stellen.

IV. Versand, Gefahrenübergang

- Verpackung, Versandweg und Transportmittel sind unserer Wahl überlassen, es sei denn, es ist zwischen den Parteien etwas anderes vereinbart.
- Die Gefahr des zufälligen Untergangs und der zufälligen Verschlechterung der Ware geht mit der Übergabe, beim Versendungskauf mit der Auslieferung der Sache an den Spediteur, den Frachtführer oder der sonst zur Ausführung der Versendung bestimmten Person oder Anstalt, auf den Besteller über. Der Übergabe steht es gleich, wenn der Besteller im Verzug der Annahme ist.
- Ware aus Abrufaufträgen ist, wenn nicht anders vereinbart, innerhalb von 3 Monaten nach Erteilung der Auftragsbestätigung abzunehmen.
- Versicherung gegen Bruch- und Transportrisiken werden nur auf besonderen Wunsch gegen Berechnung der Kosten übernommen.
- Zoll und sonstige Spesen, auch die Unkosten für Bezahlung der zur Einfuhr in das Bestimmungsland notwendigen Papiere, gehen zu Lasten des Käufers.

V. Zahlung, Zahlungsbedingungen

- Rechnungen sind zahlbar:
 - innerhalb von 14 Tagen ab Rechnungsdatum mit 2 % Skonto vom Rechnungswert.
 - innerhalb von 30 Tagen ab Rechnungsdatum ohne Skonto vom Rechnungswert.
- Kassa - Skonto wird nur gewährt, wenn sämtliche Zahlungsverpflichtungen aus früheren Lieferungen erfüllt sind und der Rechnungsbetrag pünktlich bis zu den vorgenannten Fälligkeitstagen bei uns in bar vorliegt oder unserem Konto gutgeschrieben ist. Wechselheringabe kann also nicht zur Gewährung von Kassa -Skonto führen. Bei bargeldloser Zahlung, insbesondere auch bei Scheckheringabe, kommt es auf den Zeitpunkt der Gutschrift an. Bei Zahlung oder Gutschrift unter Vorbehalt, unter einer Bedingung oder sonstigen Einschränkungen kann Skonto nicht gewährt werden. Das Risiko des Zahlungsweges trägt der Besteller. Rechnungen für

- Werkzeuge sind ohne Skontoabzug sofort zahlbar.
- Die Annahme von Wechseln und Schecks erfolgt nur erfüllungshalber. Entsprechende Gutschriften erfolgen nur unter Vorbehalt des Einganges des vollen Betrages. Die Hereinnahme von fremden oder eigenen Akzepten behalten wir uns vor. Kosten und Diskontspesen gehen zu Lasten des Bestellers. Eine Gewähr für Vorlage und Protest übernehmen wir nicht. Protesterhebung eigener Wechsel des Bestellers oder nicht sofortige Abdeckung protestierter Fremdwechsel ermächtigen uns, sämtliche noch laufende Wechsel zurückzugeben. Gleichzeitig sind wir berechtigt, nicht fällige Forderungen gegen den Besteller sofort fällig zu stellen. Vordatierte Schecks werden nicht angenommen.
 - Bei Überschreitung des Zahlungstermins werden Verzugszinsen in Höhe von 9 %-Punkten über dem jeweiligen Basiszinssatz gem. § 247 BGB sowie eine Verzugschadenspauschale in Höhe von 40,00 Euro gem. § 288 Abs. 5 BGB fällig. Die Geltendmachung eines weiteren Verzugschadens oder anderer Rechte bleibt vorbehalten.
 - Voraus- und Abschlagszahlungen werden nicht verzinst.
 - Zur Aufrechnung oder Einbehaltung von Zahlungen ist der Besteller nur berechtigt, wenn seine Gegenforderung unbestritten oder rechtskräftig festgestellt ist. Der Besteller kann ein Zurückbehaltungsrecht nur ausüben, wenn sein Gegenanspruch auf demselben Vertragsverhältnis beruht.
 - Beim Ausgleich von Rechnungen sind vom Besteller seine Kundennummer und die Rechnungsnummer anzugeben. Verzögerungen oder Fehlbuchungen, die infolge Nichteinhaltung dieser Verpflichtungen eintreten, gehen zu Lasten des Bestellers.

VI. Eigentumsvorbehalt, Factoring

- Die gelieferte Ware bleibt bis zur Bezahlung aller bestehenden Forderungen aus der Geschäftsverbindung mit dem Besteller unser Eigentum. Der Besteller ist im Rahmen des ordnungsgemäßen Geschäftsganges zur Weiterveräußerung der Vorbehaltsware berechtigt; eine Verpfändung oder Sicherungsübereignung ist ihm jedoch nicht gestattet. Bei einem Weiterverkauf von Vorbehaltsware auf Kredit ist er verpflichtet unsere Rechte zu sichern.
- Die Forderungen des Bestellers aus der Weiterveräußerung der Vorbehaltsware tritt dieser schon jetzt in Höhe des Rechnungsbetrages an uns ab; Wir nehmen diese Abtretung an. Ungeachtet der Abtretung ist der Besteller zur Einziehung solange berechtigt, als er seinen Verpflichtungen uns gegenüber aus dem zugrundeliegenden Vertragsverhältnis nachkommt und nicht in Vermögensverfall gerät. Andernfalls hat er auf unser Verlangen die zur Einziehung erforderlichen Angaben über die abgetretene Forderung zu machen und seinen Schuldners diese Abtretung anzuzeigen. Für diesen Fall behalten wir uns vor, die Forderung selbst einzuziehen.
- Eine etwaige Be- oder Verarbeitung der Vorbehaltsware durch den Besteller erfolgt stets im Namen und im Auftrag für uns, ohne dass uns jedoch Verbindlichkeiten hieraus erwachsen dürfen. Bei der Verarbeitung der Vorbehaltsware mit anderen, uns nicht gehörenden Waren, steht uns der dabei entstandene Miteigentumsanteil an der neuen Sache im Verhältnis des Wertes der Vorbehaltsware zu der übrigen verarbeiteten Ware zu. Soweit hier und auch nachfolgend auf den Wert der Vorbehaltsware abgestellt ist, ergibt sich diese aus unserem Fakturawert.
- Erwirbt der Besteller das Alleineigentum an der neuen Sache gemäß § 947 Abs. 2 BGB, so besteht Einigkeit darüber, dass er uns im Verhältnis des Wertes der verarbeiteten bzw. verbundenen oder vermischten Vorbehaltsware Miteigentum an der neuen Sache einräumt und diese unentgeltlich für uns bewahrt.
- Wird die Vorbehaltsware zusammen mit anderen Waren, und zwar gleichgültig, ob ohne oder nach Verarbeitung, Verbindung oder Vermischung weiter veräußert, so gilt die oben vereinbarte Vorausabtretung nur in Höhe des Wertes der Vorbehaltsware, die zusammen mit den anderen Waren weiterveräußert wird. Wir verpflichten uns, die uns nach den vorstehenden Bestimmungen zustehenden Sicherungen auf Verlangen insoweit freizugeben, als der Wert die zu sichernden Forderungen mit 20 % übersteigt.
- Über Zwangsvollstreckungsmaßnahmen Dritter in die Vorbehaltsware oder die im Voraus abgetretenen Forderungen hat uns der Besteller unverzüglich unter Übergabe der für eine Intervention notwendigen Unterlagen zu unterrichten. Daraus bei uns entstehende Interventionskosten sind vom Besteller zu tragen.
- Der Besteller hat die Vorbehaltsware ausreichend gegen Feuer und Einbruchsdiebstahl zu versichern und uns dies auf Verlangen nachzuweisen.

VII. Mängelansprüche

- Die Verjährungsfrist für Mängelansprüche beträgt 24 Monate ab Ablieferung der Ware.
- Wir leisten für Mängel der Ware zunächst nach unserer Wahl Gewähr durch Nachbesserung oder Ersatzlieferung. Bei Fehlschlagen von Nachbesserung oder Ersatzlieferung kann der Besteller Rückgängigmachung des Vertrages oder Herabsetzung der Vergütung verlangen. Bei einer nur geringfügigen Vertragswidrigkeit, insbesondere bei nur geringfügigen Mängeln, steht dem Besteller jedoch kein Rücktrittsrecht zu.
- Der Besteller hat offensichtliche Mängel unverzüglich, spätestens innerhalb von 7 Tagen nach Eingang der Ware unter sofortiger Einstellung etwaiger Bearbeitung schriftlich anzuzeigen. Andernfalls ist die Geltendmachung von Mängelansprüchen ausgeschlossen. Zur Fristwahrung genügt die rechtzeitige Absendung. Den Besteller trifft die volle Beweislast für sämtliche Anspruchsvoraussetzungen, insbesondere für den Mangel selbst, für den Zeitpunkt der Feststellung des Mangels und für die Rechtzeitigkeit der Mängelrüge.
- Mängel, die auch bei sorgfältiger Prüfung innerhalb dieser Frist nicht entdeckt werden können, sind unverzüglich nach Entdeckung schriftlich zu rügen. Wählt der Besteller wegen eines Rechts- oder Sachmangels nach gescheiterter Nacherfüllung den Rücktritt vom Vertrag, steht ihm daneben kein Schadensersatzanspruch wegen des Mangels zu.
- Wählt der Besteller nach gescheiterter Nacherfüllung Schadensersatz, verbleibt die Ware beim Besteller, wenn ihm dies zumutbar ist. Der Schadensersatz beschränkt sich auf die Differenz zwischen Kaufpreis und Wert der mangelhaften Sache. Dies gilt nicht, wenn wir die Vertragsverletzung arglistig verursacht haben.
- Ware, für die wir Ersatz geleistet haben, geht in unser Eigentum über und ist an uns zurückzusenden gegen Kostenerstattung.
- Ansprüche bestehen nicht für solche Schäden, die dadurch entstanden sind,

dess der Besteller schuldhaft

- den Kaufgegenstand unangemessen behandelt oder überansprucht hat oder
- den Kaufgegenstand in einer nicht vereinbarten Weise verändert hat oder
- die Vorschriften der Montage- oder Betriebsanleitung nicht befolgt hat oder
- die Rüge- und Zustellungspflicht gemäß vorstehender Ziffer 3 und 4 verletzt hat oder
- den Kaufgegenstand nach Mangelfeststellung weiterbenutzt hat. Natürlicher Verschleiß ist von der Gewährleistung ausgenommen.

VIII. Haftung

- Bei leicht fahrlässigen Pflichtverletzungen beschränkt sich unsere Haftung auf den nach der Art der Ware vorhersehbaren, vertragstypischen, unmittelbaren Durchschlittschaden. Dies gilt auch bei leicht fahrlässigen Pflichtverletzungen unserer gesetzlichen Vertreter oder Erfüllungsgehilfen. Bei leicht fahrlässiger Verletzung unwesentlicher Vertragspflichten haften wir nicht.
- Die Haftung aufgrund übernommener Garantien sowie aufgrund Produkthaftung bleibt unberührt, ebenso bei uns zurechenbaren Körper- oder Gesundheitsschäden oder bei Verlust des Lebens des Bestellers.
- Schadensersatzansprüche des Bestellers wegen eines Mangels verjähren nach einem Jahr ab Anlieferung der Ware. Dies gilt nicht, wenn uns Vorsatz oder grobes Verschulden vorwerfbar ist, sowie im Falle von uns zurechenbaren Körper- und Gesundheitsschäden oder bei Verlust des Lebens des Bestellers.
- Als Händler und Einführer bedienen Sie eine entscheidende Rolle bei der Sicherstellung der Konformität und der Sicherheit von Produkten auf dem Markt. Als Händler und Einführer unserer Produkte sind Sie verpflichtet den gesetzlichen Bestimmungen und Verpflichtungen bzgl. Marktüberwachung nachzukommen, sollte es Hinweise auf Abweichungen geben (z.B. in Form von Reklamationen die Abweichungen zur ECE R46 oder allgemeine, sicherheitsrelevante Punkte betreffen). Bitte beachten Sie die entsprechende Meldepflicht bezüglich genannter Auffälligkeiten. Die Meldung sollte in Form von transparenten und nachvollziehbaren Informationen an uns erfolgen. Bitte wenden Sie sich an Ihren Ansprechpartner im Vertriebssteam.

IX. Rücknahme

- Ordnungsgemäß bestellte und gelieferte Ware wird grundsätzlich nicht zurückgenommen. Ausnahmen bilden Rücknahmen, die mit uns vereinbart wurden. Zusätzlich müssen folgende Voraussetzungen erfüllt werden:
- Die Produkte müssen von uns oder von einem unserer Werkslager direkt bezogen worden sein.
 - Einwandfreier und unveränderter Zustand der Ware.
 - Grundsätzlich ist die Rücknahme durch uns nur dann möglich, wenn die zur Rückgabe vorgesehenen Teile noch im Lieferprogramm sind.
 - Rückversand muss „frei Haus“ an unser Werk Ergersheim oder an das zuständige Werkslager unter Angabe von Lieferscheindatum und -nummer erfolgen. Werbschlag bei Rücknahme:
 - im 1. Jahr nach Liefertag / .10 % vom Lieferpreis
 - im 2. Jahr nach Liefertag / .25 % vom Lieferpreis
 - zwischen 3. und 5. Jahr nach Liefertag / .50 % vom Lieferpreis
 - Ware älter als 5 Jahre keine Rücknahme möglich.
 Nach Erhalt der Teile erfolgt die technische Überprüfung und Erstellung der Gutschrift unter Berücksichtigung eines etwaigen Wertabschlages. Frachtkosten, sofern sie für den ursprünglichen Versand für uns entstanden sind, vermindern den Restwert.

X. Schutzrechte

- Bei kundenspezifischen Sonderanfertigungen haftet der Besteller uns für die Freiheit von Schutzrechten Dritter der in Auftrag gegebenen Lieferungen, stellt uns von etwaigen Ansprüchen Dritter frei und hat uns etwaigen aus einer Verletzung dieser Pflicht resultierenden Schaden zu ersetzen.
- Unsere Entwürfe und Konstruktionsvorschlüsse sind vertraulich zu behandeln und dürfen nicht an Dritte weitergegeben werden.
- Sämtliche Zeichnungen, Konstruktionspläne und Muster, die dem Besteller zugegangen sind, bleiben unser geistiges Eigentum.

XI. Erfüllungsort, Gerichtsstand, sonstige Vereinbarungen

- Als Beschaffenheit der Ware gilt grundsätzlich nur unsere Produktbeschreibung als vereinbart. Öffentliche Ausstellungen, Anpreisungen oder Werbung durch uns stellen daneben keine vertragsgemäße Beschaffenheitsangabe der Ware dar. Proben und Muster gelten als annähernde Anschauungsstücke für Qualität, Abmessungen und Farbe. Rechtsansprüche können hieraus nicht abgeleitet werden. Technische Änderungen sowie Änderungen in Form, Farbe und/oder Gewicht bleiben uns im Rahmen des Zumutbaren vorbehalten.
- Erhält der Besteller eine mangelhafte Montageanleitung, sind wir lediglich zur Lieferung einer manglefreien Montageanleitung verpflichtet und dies auch nur dann, wenn der Mangel der Montageanleitung der ordnungsgemäßen Montage entgegensteht.
- Garantien im Rechtssinne erhält der Besteller durch uns nicht; Herstellergarantien bleiben hiervon unberührt.
- Erfüllungsort für unsere Lieferungen ist bei Lieferung ab Werk das Lieferwerk, bei Lieferung ab Lager das Lager. Erfüllungsort für alle Zahlungen ist Ergersheim / Bayern, Deutschland.
- Ausschließlicher Gerichtsstand für alle Streitigkeiten aus diesem Vertrag ist Fürth / Bayern, Deutschland. Dies gilt auch für evtl. Scheck- und Wechselklagen.
- Es gilt das Recht der Bundesrepublik Deutschland. Die Bestimmungen des UN-Kaufrechts finden keine Anwendung. Es ist allein der Text der deutschsprachigen Fassung dieser Allgemeinen Geschäftsbedingungen maßgeblich.
- Ergänzend gelten die mit den jeweiligen Preislisten bekannt gegebenen Sonderbedingungen unserer Produkte.
- Der Besteller ist selbst dafür verantwortlich, die Eignung von Waren für den beabsichtigten Verwendungszweck zu prüfen.
- Hinweis gemäß Bundesdatenschutzgesetz: Die zur Auftragsabwicklung erforderlichen Bestellerdaten werden gespeichert.

Stand 06/2024

GENERAL TERMS AND CONDITIONS OF SALE AND DELIVERY

I. General Provisions

1. The provisions of the contract between MEKRA Lang GmbH & Co. KG ("MEKRA Lang") and our orderers who are contractors as defined in para. 14 BGB are solely governed by these General Terms and Conditions. Our offers are exclusively meant for entrepreneurs as defined by Article 4 BGB (German Civil Code). Deviating business terms of the customer, even if they are known to us, shall not become a part of the contract. Our offers are always subject to change without notice. Our General Terms and Conditions of Sale and Delivery are considered accepted upon placement of order, at the latest upon receipt of goods. In the case of repeated business relations these General Terms and Conditions of Sale and Delivery also apply for all future transactions. Should individual provisions be or become completely or partially ineffective, then the validity of the other provisions shall thereby not be affected. MEKRA Lang and the customer shall agree upon a regulation the economic success of which shall be as close as possible to the ineffective one. Until such agreement the laws, administrative practice and judicature effective at the time of execution are to be applied.

II. Conclusion of Contract and Prices

1. By ordering merchandise the customer bindingly declares that he wants to buy the merchandise ordered. He shall be bound to this statement for two weeks. We are entitled to accept the offer of a contract underlying the order within two weeks upon receipt of the latter by us. The acceptance may be declared in writing, electronically, or by delivery of the goods to the customer.

2. The obligations in electronic commerce according to Section 312e, par. 1 sentence 1, Nos. 1 to 3, and sentence 2 of BGB (German Civil Code) are excluded.

3. The conclusion of the contract takes place subject to the correct and timely delivery by our sub-suppliers to us. This applies only in case we are not responsible for the non-delivery, especially in case of the conclusion of a congruent hedging business transaction with our sub-suppliers. The customer shall be informed about the non-availability of the product without delay, and the equivalent, insofar as already paid, shall be reimbursed immediately.

4. All contractual financial obligations are to be fulfilled solely in EURO.

5. Prices are understood to be net as ex factory or supply depot (according to Incoterms 2020). Freight, packaging and import costs, customs duties and other additional taxes are payable by the customer.

III. Period of Delivery and Supply Commitment

1. Our written or electronic order confirmation shall be decisive for extent, type, and date of the delivery. Partial shipments shall be permitted.

2. A liability in meeting delivery deadlines determined as binding shall only be accepted under the condition of undisturbed flow of operations and distribution. In particular in cases of acts of God and other disruptive events at our facilities or those of our sub-suppliers or transport contractors, for example operational or traffic disruptions, fire, flooding, labour-, energy-, or traffic shortages, strikes, lockouts, official measures as well as technical or technological situations that considerably aggravate the execution of the contract, release us from liability in punctual delivery or give us the right to stop delivery without obligation for subsequent delivery.

3. If not agreed otherwise, we have the right to deliver earlier than the delivery deadline. Unless otherwise agreed upon, delivery effected by us one up to a maximum of two weeks after the stipulated delivery date shall not be considered as delayed.

4. Delivery deadlines shall be considered met when the goods have left the works or dispatch depot or the customer has received notice by expiration of the deadline of our readiness to deliver. Subsequent alteration of contract shall be cause for a reasonable extension of delivery deadlines.

5. In the case of contracts whose performance consists of several deliveries, non-performance, defective or delayed performance of one delivery remains without influence upon the other deliveries of the contract.

6. Default of payments, handing in of a state meant in lieu of an oath of disclosure in accordance with § 807 ZPO (German Code of Civil Procedure), temporary shortage of liquid funds, or public knowledge of a considerable deterioration of the financial circumstances of the customer shall entitle us at our discretion to demand payment in advance for outstanding deliveries or to stop deliveries immediately and to deny performance of current contracts. At the same time we shall be entitled to make immediately due and payable those accounts receivable from the customer which are not due yet.

IV. Shipment, Passage of Risk

1. Unless otherwise agreed by the Parties, the choice of packaging, shipping routes and method of transportation is subject to our discretion.

2. The risk of accidental loss and accidental deterioration of the merchandise shall pass over to the customer upon handing it over, in case of a mail order purchase upon delivery of the matter to the forwarding agent, the carrier, or another person or institution determined to execute the shipment. If the customer is overdue in accepting, this shall be equal to a handing over of the merchandise.

3. Merchandise out of call orders shall be accepted within 3 months after issuance of the acknowledgement of order, unless otherwise agreed.

4. Insurance against breakage and transportation risks shall only be taken out upon special request and shall be billed.

5. Customs duties and other expenses, also the costs for payment of the necessary papers for import into the country of destination, shall be payable by the customer.

V. Payments, Terms of Payment

1. Invoices shall be payable:

- within 14 days from date of invoice with 2 % cash discount of the accumulated invoice value;
- within 30 days from date of invoice without cash discount of the accumulated invoice value.

2. Cash discount shall only be granted after all payment commitments out of earlier deliveries have been fulfilled and the invoice amount has been punctually paid to us in cash or has been credited to our account by the aforementioned due dates. The drawing of a bill of exchange can thus not lead to the granting of a cash discount. In case of cashless payment, especially when a cheque is submitted, the date of the credit entry shall be decisive. A cash discount cannot be granted in the case of payment or credit

entry under reserve, with limiting conditions or any other restrictions. The customer shall assume all risks of method of payment. Invoices for tools are subject to immediate payment without cash discount.

3. Bills of exchange and checks shall only be accepted on account of payment. Corresponding credit entries are made only under the limiting condition of correct receipt of the complete amount due. We reserve the right to take in external or own acceptances. Costs and discount expenses are payable by the customer. We assume no responsibility for submission and protest. Protest imposed against the customer's own bills of exchange or non-immediate repayment of protested external bills of exchange shall entitle us to return all bills in circulation. At the same time we shall be entitled to make immediately due and payable those accounts receivable from the customer which are not yet due. Antedated checks shall not be accepted.

4. Interest on defaulted payment of 9%-points over the discount rate of the German Central Bank referred to in § 247 BGB (German Civil Law) as well as a liquidated damages of 40,00 Euro shall be charged in the case of missed payment dates. The right of assertion of further damages caused by delayed performance and other claims shall remain reserved.

5. Advance and part payments are not subject to interest payments.

6. The customer shall only be entitled to offset or withhold payment if his counterclaim is undisputed or has been determined legally binding. The customer may execute a right of retention only if his counter claim is based on the same contractual relationship.

7. Customer and invoice numbers are to be given by the customer when invoices are balanced. Delays or incorrect booking resulting from failure to do so shall be payable by the customer.

VI. Retention of Ownership, Factoring

1. The delivered goods shall remain our property until payment of all claims has been received. The customer has the right to resell the proviso goods within the scope of proper and orderly course of business; however, a pledge or transfer by way of security is not permissible. The customer is required to ensure our rights in the case of resale of proviso goods on credit.

2. The accounts receivable by the customer based on the resale of the merchandise subject to reservation shall now already be transferred to us in the amount of the invoice. We hereby agree to accept this transfer. Regardless of the assignment, the customer shall retain the right to collect payment under the condition that he fulfils his responsibilities to us according to the underlying contractual relationship and does not fall into financial decline. Otherwise the customer must provide the information about the assignment necessary for collection upon our demand and notify his debtors of the respective assignment. In this case we reserve the right to collect the accounts receivable by ourselves.

3. A possible finishing or processing of the merchandise sold subject to reservation by the customer shall always take place on our behalf and by order of us, without any obligations resulting for us from this, however. In the case of processing of proviso goods with other goods not belonging to us, we are entitled to the co-owner portion of the resulting product corresponding to the value of the proviso goods in relation to the other processed goods. Insofar as here and in the following the value of the proviso goods is referred to, this value results from our invoice value.

4. Should the customer acquire sole ownership of the new product according to § 947 paragraph 2 BGB, it is agreed upon that the customer grants co-ownership in the proportion of the value of the processed, attached, or mixed proviso goods, and that he protects these free of charge.

5. In the case of resale of the proviso goods together with other goods, regardless of with or without processing, attachment or mixing, the assignment in advance agreed to above shall be valid only to the extent of the value of proviso goods that were resold together with the other goods. We shall be obligated to release on demand the securities entitled as provided above, if the value exceeds secured payments by 20 %.

6. The customer must immediately notify us and provide the material necessary for an intervention in the case of compulsory execution by third parties against the proviso goods or in case of claims assigned in advance. Any costs resulting from such intervention shall be payable by the customer.

7. The customer shall be obligated to adequately insure the merchandise sold subject to reservation against fire and burglary and has to prove such insurance to us on demand.

VII. Warranty

1. The period of limitation for any warranty claim shall be 24 months as from handover of the goods.

2. First of all, we shall remedy a defect or make a substitute delivery at our discretion. In case of failure to rectify defects or to substitute delivery, the customer can demand rescission of the contract or reduction of the payment. In case there is only a minor contract violation, especially if there are only minor defects, the customer shall not have the right of contract cancellation, however.

3. The customer must notify us in writing of any obvious flaws immediately, at the latest within 7 days after receipt of the goods, and must refrain from any eventual working of protested goods. Otherwise claims based on defects are excluded. The timely dispatch shall suffice for the observance of the warranty deadline. The full burden of proof for all claim prerequisites rests with the customer, especially for the defect itself, for the date of the establishment of the defect, and for the timeliness of the complaint about the defect.

4. Defects which could not be ascertained within this time span despite careful inspection are to be reported to us in writing immediately upon discovery. If the customer opts for a withdrawal from the contract because of a legal imperfection or a physical defect after a failed subsequent fulfilment, then he shall not be additionally entitled to a claim for compensation because of the defect.

5. If, after a failed subsequent fulfilment, the customer opts for a compensation of the damage, then the merchandise shall remain with the customer if this can reasonably be considered acceptable. The compensation is restricted to the difference between the purchase price and the value of the defective product. This shall not apply if we caused the contract violation maliciously.

6. Merchandise for which we have effected compensation shall become our property and is to be returned to us against reimbursement of costs.

7. Claims cannot be made for damages that resulted from the customer's culpably

- improper handling or overstressing the purchased item or

- altering the purchased item in a manner not agreed upon or
- not following the instructions of the mounting or operating manual or
- not observing the complaint and delivery responsibility according to points 3 and 4 above or
- further using the purchased item after ascertaining the defect.

Natural wear and tear is excepted from the warranty.

VIII. Liability

1. In case of simply negligent violations of obligations our liability shall be restricted to an average damage predictable for the type of merchandise, typical for such a contract, and immediate. This also applies in case of simply negligent violations of our legal representatives or agents. We shall not be held liable in case of a simply negligent violation of nonessential contract obligations.

2. The liability by virtue of acceptance of a guarantee as well as due to product liability remains unaffected; the same applies in case of bodily harm or health impairment attributable to us or in the event of loss of life of the customer.

3. Compensation claims of the customer because of a defect shall superannuate after one year from the delivery of the merchandise to the customer. This shall not apply if we can be charged with gross negligence as well as in case of bodily harm or health impairment attributable to us or in the event of loss of life of the customer.

4. As a distributor and importer, you play an important part in ensuring the compliance and safety of products in the market. As a distributor and importer of our products, you are required to comply with the applicable legal provisions and obligations regarding market surveillance, should there be any indications of discrepancies (e.g. in the form of complaints regarding non-compliance with ECE R46 or general, safety-related issues). Please adhere to the corresponding reporting requirements in connection with the above-mentioned anomalies. Any reports to us should be comprised of transparent and verifiable information. Please contact your sales team representative.

IX. Returns

Properly ordered and delivered goods shall in principle not be taken back. Returns that have been agreed upon with us shall remain the exception, which additionally require the following pre-requisites to be met:

- The products must have been acquired directly from us or from one of our works depots.
- Flawless and unaltered condition of the goods.
- In principle, return shall only be possible when the articles in question are still in our product range.
- Return shipment must be "free domicile" to our Ergersheim works or to the appropriate works depot with accompanying delivery note date and number. Value reduction for returns:
 - in the first year after delivery date / 10 % of the contract price
 - in the second year after delivery date / 25 % of the contract price
 - between the 3rd & the 5th year after deliv.date / 50 % of the contract price
 - merchandise over five years old - no return possible
 Technical inspection and completion of the credit slip shall be carried out under consideration of eventual value reduction upon receipt of the articles. Freight costs, insofar as any occurred to us for the original shipping, reduce the remaining value.

X. Industrial Property Rights

- The customer is held liable to us for the exemption from industrial protection rights of third parties on articles ordered, indemnifies us against any possible claims of third parties and has to reimburse any damage to us possibly resulting from a violation of this obligation.
- Our designs and design proposals are to be kept confidential and may not be passed on to third parties.
- All drawings, construction plans, and samples which the customer has received, shall remain our intellectual property.

XI. Place of Fulfilment and Jurisdiction, Other Agreements

1. On principle, the product description of the manufacturer is understood to be decisive for the characteristics of the goods. Public statements, sales talks, or advertisements made apart from this do not represent a contractual description of the characteristics of the goods. Samples and specimens serve as approximate illustrative articles in terms of quality, measurements and colour. Legal claims cannot be inferred from this. Technical changes as well as alterations in shape, colour, and/or weight are reserved within reasonable scope.

2. If the customer receives a faulty assembly instruction, we shall only be obliged to furnish a faultless assembly instruction, and this only if the fault of the assembly instruction is in contradiction with a proper assembly.

3. The customer does not receive warranties in the legal sense of the word from us; warranties of the manufacturers, however, shall remain unaffected by this.

4. Place of fulfillment for our deliveries ex works shall be the delivery works, for delivery ex storage the warehouse. Place of fulfillment for all payments shall be Ergersheim / Bavaria, Germany.

5. The exclusive place of jurisdiction for all litigations from this contract shall be Fuerth / Bavaria, Germany. This also applies to lawsuits based on a cheque or bill of exchange.

6. These provisions shall be governed by the Law of the Federal Republic of Germany. The provisions of the UN Purchase Law shall not be applicable. The wording of the German language version of our "General Terms and Conditions of Sale and Delivery" shall solely be decisive for these General Business Terms.

7. The special terms of our products published with the appropriate price lists shall additionally be applicable.

8. The customer itself shall be responsible to examine the suitability of the goods for the intended final usage.

9. German law (BDSG-Federal Data Protection Law) requires us to inform you that all data of our customers are electronically saved.

As of: 06/2024



Team Aftermarket

Günther Engel, Katharina Graf, Sven Gurrath, Sven Felbinger, Yannic Rauner,
Ivonne Häupler, Marco Wiesmann

Standorte Aftermarkt

Locations for the aftermarket



MEKRALang GmbH & Co. KG

Buchheimer Str. 4
91465 Ergersheim
Germany
Hotline +49 9847 989 8757
Tel +49 9847 989-0
bestellungen@mekra.de
www.mekra.de



MEKRA Lang International ČR. spol. s.r.o

Družstevní 185
33008 Zruč
Czech Republic
Tel +42 0 377 824-893
Fax +42 0 377 824-893
mekra@mekra.cz
www.mekra.cz



MEKRA Lang do Brasil Ltda.

Avenida Paraná 2879
Cajuru do Sul - Sorocoba
SP 18105-000
Brazil
Tel +55 15 3235 3420
Fax+55 15 3235 3421
mekra@mekra.com.br
www.mekra.com.br



MEKRA FRANCE SARL

7, rue de la Prévôté
ZA de la Prévôté
78550 HOUDAN
FRANCE
Tel +33 1 30 47 43 85
contact@mekra.fr
www.mekra.fr



MEKRA Lang North America, LLC

101 Tillessen Boulevard
Ridgeway, SC 29 130
U.S.A.
Tel +1 803 337 52 64
Fax +1 803 337 52 65
sales@lang-mekra.com
http://www.lang-mekra.com



MEKRA Lang Otomotiv Yan Sanayi A.S.

Baskent Organize Sanayi Bölgesi
19. Cad. No: 60
Maliköy Sincan 06909
Ankara
Turkey
Tel +90 312 640 12 16
Fax +90 312 640 12 25
mekratrurkey@mekra-turkey.com
www.mekra-turkey.com

 Komplettspiegel (Klasse II / IV)
 complete mirror (class II / IV)
 rétroviseur complet (class II / IV)
 espelho completo (class II / IV)
 specchio completo (class II / IV)
 espejo completo (class II / IV)
 komplett spegel (class II / IV)
 kompletní zrcadlo (trída II / IV)
 зеркало в комплекте (класс II / IV)
 komple ayna (sinif II / IV)
 komplett tükör (II / IV tükörsztály)
 kompletne lustra (klasa II / IV)

 Schraube
 screw
 vis
 parafuso
 vite
 tornillo
 skrúv
 šroub
 vint
 vida
 csavar
 šrubca

 Kugelstange
 ball joint
 bras à rotule
 Junta de articulação
 staffa con snodo a sfera
 barra con cabeza esférica
 kulstang
 kulový držák
 шаровая опора
 ayna destekleyicisi
 gölyövüğü rüd
 pręt z kulka

 für 1- / 2- / 3- Spiegelbetrieb (Kabel, Schalter)
 pour 1- / 2- / 3- mirror operation (cable, switch)
 pour 1- / 2- / 3- commande(s) (câble, commutateur)
 para 1 / 2 / 3 espelhos (cabo, interruptor)
 para 1 / 2 / 3 specchi / 2 specchi / 3 specchi (cavo, interruttore)
 servicio de 1- / 2- / 3- espejo(s) (cable, conmutador)
 1- / 2- / 3- spegelstyrning (kabel, styrspek)
 pro ovládní 1 zrcadla / 2 zrcadel / 3 zrcadel (kabel, ovladač)
 для управления 1 зеркалом / управления 2 / 3 зеркалами
 1- / 2- / 3- ayna kumandasi (kablo/salter)
 1- / 2- / 3- tükör müködötés (vezetőkábel, állítókapcsoló)
 do obsługi 1, 2 lub 3 lusterek (kabele, przełącznik)

 Spiegelkopf ohne Glaseinheit (Klasse II / IV)
 mirror head without glass unit (class II / IV)
 boîtier, sans glace de rechange (class II / IV)
 cabeça de espelho sem unidade de vidro (class II / IV)
 carcassa senza vetro (class II / IV)
 carcassa, sin unidad de cristal (class II / IV)
 spegelhuvud utan glas (class II / IV)
 hlava zrcadla bez skla (trída II / IV)
 Зеркала в сборе без зеркального элемента (класс II / IV)
 cansız ayna gövdesi (sinif II / IV)
 tükörfej tükör és hordozólap nélkül (II / IV tükörsztály)
 korpusz lustra bez wkładu (klasa II / IV)

 Spiegelhalter
 mirror holder
 support
 suporte
 suporte de fixação
 supporto
 soporte
 hällare
 držák zrcadla
 несущая опора
 ayna tutucusu
 tükörtartó
 uchwyty

 Stange
 bracket
 bras de fixation
 braco de fixação
 braccio
 soporte
 spegelarm, komplett
 držák zrcadla
 трубчатый кронштейн зеркала
 ayna kolu
 tükörtartókar
 wspornik / drążek

 manuell verstellbar (Klasse II / IV)
 manually adjustable (class II / IV)
 réglage manuel (class II / IV)
 manual (class II / IV)
 regolazione manuale (class II / IV)
 manual (class II / IV)
 manuellt justerbar (Klasse II / IV)
 manuálně ovládané (trída II / IV)
 переставляется вручную (класс II / IV)
 manuel olarak ayarlanabilen (sinif II / IV)
 kézi állítású (II / IV tükörsztály)
 regulowane ręcznie (klasa II / IV)

 Komplettsystem Klasse II + IV inkl. Spiegelstange
 complete system class II + IV incl. bracket
 système complet classe II + IV, bras de rétroviseur compris
 sistema completo classe II + IV, suporte incluso
 sistema completo classe II + IV completo di braccio
 sistema completo classe II + IV, braço incluído
 komplettsystem class II + IV inkl. spegelbågar
 kompletní systém třídy II + IV včetně držáku zrcadla
 Системы класса II + IV включая кронштейн зеркала
 komple sistem sinif II + IV tutucu dahil
 komplett rendszer II és IV-es osztályú tükörökkel és karral
 kompletny system klasy II + IV + ramie lustra

 Scharnier
 hinge
 charnière
 rótula
 cerniera
 rotula
 knävel
 závěs
 шарнир
 mafsál
 csulópánt
 zawias

 Haltebock
 lower holder
 support de fixation
 suporte inferior de fixação
 supporto inferiore
 soporte bajo
 nedre hällare
 spodní držák
 держатель
 tutucu
 csukló
 uchwyt

 elektrisch verstellbar (Klasse II / IV)
 remote controlled (class II / IV)
 réglage électrique (class II / IV)
 eléctrico (class II / IV)
 regolazione elettrica (class II / IV)
 eléctrico (class II / IV)
 elektriskt justerbar (Klasse II / IV)
 elektricky ovládané (trída II / IV)
 электроуправляемое (класс II / IV)
 uzaktan kumandalı (sinif II / IV)
 elektromosan állítható (II / IV tükörsztály)
 regulowane elektrycznie (klasa II / IV)

 Busspiegel mit Gelenkarm
 bus mirror with joint arm
 rétroviseur de car avec bras articulé
 espelho para ônibus com braço articulado
 specchio per autobus con braccio snodabile
 retrovisor para autocar con brazo articulable
 busspegel med ledad arm
 zrcadlo autobusu s kloubovým ramenem
 зеркало для автобуса
 otobüs aynası
 busztükör csuklós karral
 lustro autobusu na ramieniu przegubowym

 Adapter
 adapter
 adaptateur
 adaptador
 adattatore
 adaptador
 adapter
 adaptör
 adapter
 adapter
 adapter

 Aufsteckkeil
 mounting wedge
 semelle de fixation
 cunha desmontável
 supporto a cuneo
 cuña desmontable
 monteringskil
 nástrčný klin
 установочный клин
 bağlantı parçası
 ékes csatlakozó
 klin do mocowania

 Memory-Funktion (Speicherung der Spiegeleinstellung)
 memory function (storage of the position of the mirror)
 fonction de mémoire (pour réglage du rétroviseur)
 função Memória (memoriza a posição do espelho)
 funzione memoria (della posizione dello specchio)
 función de memoria (de la posición del espejo)
 minnesfunktion (lagring av inställningar)
 функция сохранения (мемори)
 hafıza fonksiyonu (ayna pozisyonu için)
 memória funkcióval (tükör beállításá mentve)
 funkcja pamięci (pamięć ustawienia)

 Busspiegel, hängend
 bus mirror, pendant mounting
 rétroviseur de car, montage suspendu
 espelho para ônibus com montagem em posição invertida
 specchio per autobus, montaggio appeso
 retrovisor para autocar, montaje en posición invertida
 busspegel, hängande
 zrcadlo autobusu visící
 зеркало для автобуса, свисающее
 otobüs aynası, asılır tip
 busztükör függő
 lustro autobusu wiszące

 Aufsteckkeil mit Direktkontakt
 mounting wedge with direct contact
 semelle de fixation avec contact direct
 cunha desmontável com elemento de contato direto
 supporto a cuneo con contatto diretto
 cuña desmontable con elemento de cont. directo
 monteringskil med direktkontakt
 nástrčný klin s přímým kontaktem
 установочный клин с прямым электроконтактом
 direk temasli bağlantı parçası
 ékes csatlakozó direkt kontaktussal
 klin do mocowania z bezpośrednim kontaktem

 manuell abklappbar
 manually retractable
 rabattable manuellement
 espelho retrátil manual
 ripiegabile manualmente
 abatible manualmente
 manuellt infällbar
 manuálně sklápny
 переставляется вручную, откидное
 manuel olarak katlanabilme
 kézzel behajtható
 ręcznie składane

 Busspiegel, stehend
 bus mirror, upright mounting
 rétroviseur de car, montage posé
 espelho para ônibus com montagem em pé
 specchio per autobus, montaggio verticale (ritto)
 retrovisor para autocar, montaje en posición de pie
 busspegel, stående
 zrcadlo autobusu stojící
 зеркало для автобуса, стоячее
 otobüs aynası, dik tip
 busztükör álló
 lustro autobusu stojące

 Faltenbalg
 rubber boot
 soufflet de protection
 carregador de borracha
 soffietto
 guardapolvo
 gummitalg
 manžeta
 резиновая гофра
 körük
 gumiharmonika
 ostona / manczeta

 elektrisch abklappbar
 electrically retractable
 rabattable électriquement
 espelho retrátil eléctrico
 ripiegabile elettricamente
 abatible electricamente
 elektriskt infällbar
 elektricky sklápny
 переставляется электр., откидное
 motorlu olarak katlanabilme
 elektromosan behajtható
 elektrycznie składane

 Glaseinheit (Klasse II / IV)
 glass unit (class II / IV)
 glace sur support plastique (class II / IV)
 unidade de vidro (class II / IV)
 vetro con supporto in plastico (class II / IV)
 unidad de cristal (class II / IV)
 glas på platta (class II / IV)
 sklo s deskou (trída II / IV)
 зеркальный элемент с подножкой держателя (класс II / IV)
 ayna camı, plastik muhafazalı (sinif II / IV)
 tükör hordozólapal (II / IV tükörsztály)
 wkład lustra (klasa II / IV)

 Heizkabel, 2 polig (runder / ovaler Winkelstecker)
 heating cable, double pole (right angle connector, round / oval)
 câble chauffant, bipolaire (connexion fiche coudée ronde / ovale)
 cabo de aquecimento, bipolar (pino lateral, redondo / ovalado)
 cavo, bipolare (attacco 90°, rotondo / ovale)
 cable de calefacción, bipolar (clavija lateral, redondo / ovalado)
 kabel für uppvärmning, 2-polig (vinkelkontakt rund / oval)
 vyhřívací kabel, 2-pólový (kruhová / oválná úhlová zástrčka)
 кабель подкл. нагревателя, двухполюсной,
 (круглая угловая вилка /)
 ısıtıcı kablo, çift kutup (dik açılı konektör, yuvarlak / oval)
 2 polusna fűtőkábel ovális / kerek csatlakozóval
 przewód grzejny, 2 pin (okrągłe / owalne, wtyczka pod kątem)

 12 V
 24 V
 beheizt (12 / 24 Volt)
 heated (12 / 24 Volt)
 chauffant (12 / 24 Volt)
 aquecido (12 / 24 Volt)
 riscaldato (12 / 24 Volt)
 calefactado (12 / 24 Volt)
 med värme (12 / 24 Volt)
 vyhřívané (12 / 24 Volt)
 напр. обогревателя (12/24 вольт)
 ısıtıcı (12 / 24 Volt)
 fűtött (12 / 24 Volt)
 ogrzewanie (12/24 V)

 Ersatzglas
 spare glass
 glace de rechange
 vidro de reposição
 vetro di ricambio
 cristal de repuesto
 ayna camı
 csere tükörlap
 szkło wymienne

 Heizfolie
 heating foil
 feuille chauffante
 manta aquecedora
 resistenza
 lámina de calefacción
 värmeelement
 vyhřívací fólie
 нагревательный элемент
 ısıtıcı folyo
 fűtőfólia
 mata grzewcza

 Steuerkabel
 control cable
 câble de commande
 cabo de controle
 cavo di controllo
 cable de control
 kabel för elstyrning
 ovládací kabel
 кабель управления
 kontrol kablou
 vezetőkábel
 kabel strowania

 Versorgungsleitung
 supply cable
 câble d'alimentation
 cabo de alimentación
 cavo di alimentazione
 cable distribuidor
 elkabel
 zdrojový kabel
 провод питания
 besleme kablou
 betápkábel
 przewód zasilania

 12 V
 24 V
 Spannung (12 / 24 Volt)
 voltage (12 / 24 Volt)
 voltage (12 / 24 Volt)
 voltagem (12 / 24 Volt)
 tensione (12 / 24 Volt)
 voltaje (12 / 24 Volt)
 spänning (12 / 24 Volt)
 napětí (12 / 24 Volt)
 напряжение (12 / 24 вольт)
 volt (12 / 24 Volt)
 feszültség (12 / 24 Volt)
 napięcie (12/24 V)

 Abdeckung (Klasse II / IV)
 back cover (class II / IV)
 cache (class II / IV)
 cobertura traseira (class II / IV)
 calotta (class II / IV)
 pared dorsal (class II / IV)
 bakstykke (class II / IV)
 zadní kryt (trída II / IV)
 задняя крышка корпуса (класс II / IV)
 arka kapak (sinif II / IV)
 burkolat (II / IV tükörsztály)
 pokrywa lustra (klasa II / IV)

 Spiegelverstellungsschalter
 mirror switch
 commutateur de rétroviseur
 interruptor do espelho
 interruttore
 conmutador de espejo
 styrspek
 ovladač zrcadel
 блок управления
 ayna kumanda düğmesi
 tükörállító kapcsoló
 przełącznik regulacji

 15 W
 30 W
 Leistungsaufnahme (Watt)
 power consumption (Watt)
 puissance en watt
 consumo de energia (Watt)
 potenza (Watt)
 consumo de energia (wattios)
 strömförsörjning (Watt)
 píkón (Watt)
 потребляемая мощн. (ватт)
 güç tüketimi (Watt)
 teljesítmény (watt)
 pobór mocy (wat)

 Haltelasche (mit / ohne Schraube)
 clamping device (with / without screw)
 collier de fixation (avec / sans vis)
 abraçadeira (com / sem parafuso)
 dispositivo di bloccaggio (con / senza vite)
 abrazadera (con / sin tornillo)
 klammer (med / utan skrúv)
 svorka (s / bez šroubu)
 серга-держатель / зажимной элемент (с / без винта)
 kelepçe (vidalı / vidasız)
 bilincs (csavarral / csavar nélkül)
 obejmka (z / bez śruby)

 kompletter Kabelsatz für elektrisch verstellbare Spiegel
 complete cable set for remote controlled mirrors
 kit complet pour réglage électrique
 kit completo de cabos para espelhos elétricos
 set di cavi per specchi elettrici
 juego completo de cables para espejos eléctricos
 kabelsats för eljusterbara speglar
 kompletní kabelová sada pro elektricky ovládaná zrcadla
 полный комплект кабелей с блоком управления для электроуправляемых зеркал
 uzaktan kumandalı aynalar için kablo seti
 komplett kábelköteg elektromosan állítható tükörkhöz
 komplet kabló do lustra sterowanego elektrycznie

 asphärisch
 aspherical
 non-sphérique
 esférico
 asferic
 asférické
 asferisches
 asferiki
 asferyczne

 Farbe schwarz / grau / chrom
 colour black / grey / chrome
 couleur noire / grise / chrome
 cor preto / cinza / cromado
 colore nero / grigio / cromo
 color negro / gris / cromo
 färg svart / grå / krom
 barva černá / šedivá / chromová
 цвет: чёрный / серый / хром
 renk siyah / gri / krom
 fekete / szürke / króm színben
 kolor: czarny / szary / chromowy

 Reduzierhülse
 reducing sleeve
 manchon de réduction
 riduttore
 la reducción de manga
 hylsa
 redukční pouzdro
 ограничивающая втулка
 düşürücü rakor
 csökkentőtűvel
 tuska redukująca

 Getriebe
 actuator
 moteur
 motor
 motorek
 hajtómű
 электропривод
 tryby sterujące

 Blinker (-Gehäuse)
 indicator (housing)
 incitogant
 luz de seta (com capa)
 freccia (lampeggiatore)
 intermitente
 köriktningsvisare
 blinker
 указатель поворота
 sinyal lamba yuvası
 index (ház)
 obudowa kierunkowskazu

 Glühbirne
 light bulb
 ampoule
 lampada
 lampadina
 bombilla
 glódlampa
 zárovka

Anbau • mounting • assemblage • montage • montaggio • montaje
montering • montáž • монтаж • montaj • gyűlekezés • montáz

Verwendung • application • aplicação • applicazione • aplicación
osňokan • použití • применение • Kullanimi • alkalmazás • aplicacja

links / rechts einsetzbar
applicable for left / right hand side
applicable à gauche / à droite
aplicável para esquerda / direita
per applicazione sinistro / destro
aplicable para izquierda / derecha
justerbar vänster / höger
použitelné pro levou i pravou / levou/pravou stranu
для применения слева / справа
sol ve sağ tarafa kullanilabilen / sol/sağ tarafa kullanilabilen
bal / jobb oldalra felszerelhető
montáz: strana lewa / prawa

Anbau oben / unten
mounting top / bottom
montage haut / bas
montagem superior / inferior
montaggio superiore / inferiore
montaje superior / inferior
Montering upp / ned
montáž nahoru / dolů
монтаж сверху / снизу
montaj üst / alt
felül / alul szerelt
montáz góra / dót

für links / rechts gesteuerte Fahrzeuge
for left / right hand driven vehicles
pour véhicules conduites à gauche / à droite
para veículos conduzidos pela esquerda / direita
per veicoli con guida sinistra / destra
para vehiculos conducidos a la izquierda / a la derecha
fűr vänster / högerstyrda fordon
pro levo / pravostraně řízená vozidla
для автомобилей с рулём слева / справа
sol ve sağdan direksiyonlu araçlar için
soldan / sağdan direksiyonlu araçlar için
bal / jobb oldalt vezetett járművekhez
dla ruchu lewo i prawo stronnego

links einsetzbar für rechts gesteuerte Fahrzeuge
applicable left hand side for right hand drive vehicles
applicable à gauche pour véhicules conduites à droite
aplicável para esquerda / veículos conduzidos pela direita
per applicazione sinistro per veicoli con guida destra
aplicable para izquierda / vehiculos conducidos a la derecha
justerbar vänster för högerstyrda fordon
použitelné pro pravou stranu pro levostranně řízená vozidla
для применения справа, в автомобиле с рулём слева
sağdan direksiyonlu araçlar için sol tarafa kullanilabilen
bal oldalra felszerelhető, jobb oldalon vezetett járművekhez
strona lewa dla ruchu prawostronnego

rechts einsetzbar für links gesteuerte Fahrzeuge
applicable right hand side for left hand drive vehicles
applicable à droite pour véhicules conduites à gauche
aplicável para direita / veículos conduzidos pela esquerda
per applicazione destro per veicoli con guida sinistra
aplicable para derecha / vehiculos conducidos a la izquierda
justerbar höger för vänsterstyrda fordon
použitelné pro pravou stranu pro levostranně řízená vozidla
для применения справа, в автомобиле с рулём слева
soldan direksiyonlu araçlar için sağ tarafa kullanilabilen
jobb oldalra felszerelhető, bal oldalon vezetett járművekhez
strona lewa dla ruchu lewostronnego

links einsetzbar für links gesteuerte Fahrzeuge
applicable left hand side for left hand drive vehicles
applicable à gauche pour véhicules conduites à gauche
aplicável para esquerda / veículos conduzidos pela esquerda
per applicazione sinistro per veicoli con guida sinistra
aplicable para izquierda / vehiculos conductos a la izquierda
justerbar vänster för vänsterstyrda fordon
použitelné pro levou stranu pro levostranně řízená vozidla
для применения слева, в автомобиле с рулём слева
soldan direksiyonlu araçlar için sol tarafa kullanilabilen
jobb oldalra felszerelhető, bal oldalon vezetett járművekhez
strona lewa dla ruchu lewostronnego

rechts einsetzbar für rechts gesteuerte Fahrzeuge
applicable right hand side for right hand drive vehicles
applicable à droite pour véhicules conduites à droite
aplicável para direita / veículos conduzidos pela direita
per applicazione destro per veicoli con guida destra
aplicable para derecha / vehiculos conductos a la derecha
justerbar höger för högerstyrda fordon
použitelné pro pravou stranu pro pravostraně řízená vozidla
для применения справа, в автомобиле с рулём справа
sağdan direksiyonlu araçlar için sağ tarafa kullanilabilen
jobb oldalra felszerelhető, jobb oldalon vezetett járművekhez
strona lewa dla ruchu lewostronnego

1990 Fahrzeugbreite
width of vehicle
2300 largeur de véhicule
largura do veículo
larghezza del veicolo
anchura del vehículo
fordonsbredd
šířka vozidla
ширина автомобиля
araç genişliği
járműszélesség
szerokość pojazdu

Anbau am Türrahmen
mounting on the door frame
montage cadre portière
montado na porta
montaggio su cornice porta
montaje en el marco de la puerta
montering på dörrkarm
montáž na rám dveří
монтаж на раму двери
araç kapı çerçevesine montaj
ajtkeretre szerelhető
montaż na drzwiach

integrierter Halter
integrated holder
support intégré
suporte de fixação integrado
supporto integrato
soporte integrado
integrerad hållare
integrovaná montáž
интегрированный
tűmleők anyá tutucusu
integrált tartó
zintegrowany uchwył

17° Winkelstellung
angularity
angle of fixation
ángulo
angolatura
angularidad
winkel
űhel nastaveni
yrol
açı pozisyonu
szögállás
położenie
kątowe

Material • matériel • materiale • material
материал • materiyal • anyag • materiał

ABS Spiegelgehäuse: Kunststoff ABS (schwarz / grau)
mirror housing: plastic ABS (black / grey)
bořtier: matière plastique ABS (noir / argenté)
carcaça: plástico ABS (preto / cinza)
carcassa: plastica ABS (nero / grigio)
carcasa: plástico ABE (negro / gris)
spegelhus: plast ABS (svart / grå)
skořepina zrcadla: umělá hmota ABS (černá / šedivá)
корпус зеркала: пластмасса ABS (цвет чёрный / серый)
ayna gövdesi plastik ABS (siyah / gri)
tűkőrház ABS-ből (fekete / szürke)
obudowa lustra: tworzywo ABS (kolor czarny / szary)

ASA Spiegelgehäuse: Kunststoff ASA, schwarz
mirror housing: plastic ASA, black
bořtier: matière plastique ASA, noir
carcaça: plástico ASA, preto
carcassa: plastica ASA, nero
carcasa: plástico ASA, negro
spegelhus: plast ASA, svart
skořepina zrcadla: umělá hmota ASA, černá
корпус зеркала: пластмасса АСА, цвет чёрный
ayna gövdesi plastik ASA, siyah
tűkőrház ASA-ből, fekete
obudowa lustra: tworzywo ASA, kolor czarny

PP Spiegelgehäuse: Kunststoff PP (Polypropylen), schwarz
mirror housing: plastic PP (polypropylene), black
bořtier: matière plastique PP (polypropylène), noir
carcaça: plástico PP (polipropileno), preto
carcassa: plastica PP (polipropilene), nero
carcasa: plástico PP (polipropileno), negro
spegelhus: plast PP (polypropylen), svart
skořepina zrcadla: umělá hmota PP (Polypropylen), černá
корпус зеркала: пластмасса Полипропилен, цвет чёрный
ayna gövdesi plastik PP (Polipropilen), siyah
tűkőrház PP-ből, fekete
obudowa lustra: tworzywo PP (polipropylen), kolor czarny

PC Spiegelgehäuse: Kunststoff PC (Polycarbonat) schwarz
mirror housing: plastic PC (Polycarbonat) black
bořtier: matière plastique PC (Polycarbonat) noir
Carcaça: plástico PC (Policarbonato) preto
carcassa: plastica PC (Polycarbonato) nero
carcasa: plástico PC (Polycarbonato) negro
spegelhus: plast PC (Polycarbonat) svart
skořepina zrcadla: umělá hmota PC (Polycarbonat) černá
корпус зеркала: пластмасса Поликарбонат, цвет чёрный
ayna gövdesi plastik polycarbonat siyah
tűkőrház PP-ből, fekete
obudowa lustra: tworzywo PC (poliwęglan), kolor czarny

PU Spiegelstange umschäumt mit PU (Polyurethan)
mirror bracket foamed with PU (polyurethan)
le bras du rétroviseur est recouvert de polyuréthane
Braço revestido de espuma sintética PU (Poliuretano)
braccio schiumato con PU (polyurethan)
brazo revestido de espuma sintética PU (Polyuretano)
spegelarm i skumformad PUR (polyuretan)
trubka držáku zpětného zrcadla zalisovaná v Polyurethanu
брус зеркала покрытый ПУ (полиуретаном)
ayna kolu polyüretan kaplı
tűkőrtartó kar habosított PU-val borítva
ramię lustra wyścietlane PU (poliuretana)

verzinktes Stahlblech
galvanized sheet steel
bořtier en tôle zinguée
chapa de aço galvanizada
acciaio zincato
carcasa de chapa de acero galvanizada
galvaniserad plát
pozinkovaný plech
оцинкованная листовая сталь
galvanizált metal plaka
horganyzott acéllemez
blacha ocynkowana

St Stahlrohr
steel tube
tube en acier
tubo de aço
tubo in acciaio
tubo de acero
stálrör
ocelová trubka
стальная трубка
çelik boru
acélcső
rura stalowa

Alu Alurohr
aluminium tube
tube en aluminium
tubo de aluminio
tubo de alluminio
tubo de aluminio
aluminiumrör
hliníková trubka
алюминиевая трубка
alüminyum boru
alucső
rura aluminiowa

Zeitraum • space of time • espace de temps • período de tempo
periodo di tempo • espacio de tiempo • period • období
период времени • dőnem • időbeni kiterjesztés • okres czasu

verwendbar ab Baujahr ... des Fahrzeugs (Monat / Jahr)
usable from year of production ... of the vehicle (month / year)
utilisable à partir de l'année ... du véhicule (mois / an)
aplicado a partir da data de produção do veículo (mês / ano)
utilizzabile dall'anno di produzione del veicolo (mese / anno)
utilizable desde el año de fabricación del vehículo (mes / año)
användbar för fordon med produktionsår from (månad / år)
použitelné od roku výroby vozidla (měsíc / rok)
применять до ... года изготовления (год / месяц)
Aracın üretim yılından sonra kullanilabilir (ay / yıl)
alkalmazható ... évjáratról (év / hónap)
rok budowy pojazdu od ... (miesiąc / rok)

verwendbar bis Baujahr ... des Fahrzeugs (Monat / Jahr)
usable until year of production ... of the vehicle (month / year)
utilisable jusqu'à l'année ... du véhicule (mois / an)
aplicado até a data de produção do veículo (mês / ano)
utilizzabile fino all'anno di produzione del veicolo (mese / anno)
utilizable hasta el año de fabricación del vehículo (mes / año)
användbar för fordon med produktionsår to (månad / år)
použitelné do roku výroby vozidla (měsíc / rok)
применять до ... года изготовления (год / месяц)
Aracın üretim yılına kadar kullanilabilir (ay / yıl)
alkalmazható ... évjáratig (év / hónap)
rok budowy pojazdu do ... (miesiąc / rok)

Zeitraum
space of time
espace de temps
período de tempo
periodo di tempo
espacio de tiempo
period
obdobi
период времени
dőnem
időbeni kiterjesztés
okres czasu

Spiegelklassen • mirror classes • classes de rétroviseurs • classes de espelhos
classi di specchio • classes de retrovisores • spegellasser • třídy zrcadel
классы зеркал • ayna siniflari • tükürösztylyok • klasy luster

I Spiegelklasse I (Innenspiegel)
mirror class I (interior mirror)
rétroviseur classe I (miroir intérieur)
espelho classe I (espelho interior)
specchio classe I (specchio interno)
espejo clase I (espejo interior)
spegelklass I (innerspegel)
zrcadlo třídy I (zrcadlo vnitřní)
зеркало класс I (внутреннее зеркало)
sinif I ayna (iç ayna)
I tükürösztyly (belső tükör)
lustra klasy I (wsteczne)

II Spiegelklasse II / III (Hauptspiegel)
mirror class II / III (main mirror)
rétroviseur classe II / III (rétroviseur principal)
espelho classe II / III (espelho principal)
specchio classe II / III (retrovisore principale)
espejo clase II / III (espejo principal)
spegelklass II / III (huvudspegel)
zrcadlo třídy II / III (zrcadlo hlavní)
зеркало класс II / III (главное зеркало)
sinif II / III ayna (ana ayna)
II / III tükürösztyly (főtükör)
lustra klasy II / III (głównie)

IV Spiegelklasse IV (Weitwinkelspiegel)
mirror class IV (wide angle mirror)
rétroviseur classe IV (rétroviseur grand angle)
espelho classe IV (espelho auxiliar)
specchio classe IV (coppa grandangolo)
espejo clase IV (espejo de gran ángulo)
spegelklass IV (vidvinkelspegel)
zrcadlo třídy IV (zrcadlo širokouhlé)
зеркало класс IV (широкоугольное зеркало)
sinif IV ayna (geniş görüş aynası)
IV tükürösztyly (nagy látószögű tükör)
lustra klasy IV (szerokokątne)

V Spiegelklasse V (Rampenspiegel)
mirror class V (roof mirror)
rétroviseur classe V (miroir d'accostage)
espelho classe V (espelho de rampa)
specchio classe V (specchio guardaruota)
espejo clase V (espejo de rampa)
spegelklass V (närskiktspegel)
zrcadlo třídy V (zrcadlo rampové)
зеркало класс V (зеркало для рамы)
sinif V ayna (kapı üstü aynası)
V tükürösztyly (rampatükör)
lustra klasy V (rampowe)

VI Spiegelklasse VI (Frontspiegel)
mirror class VI (front-under mirror)
rétroviseur classe VI (miroir frontal)
espelho classe VI (espelho frontal)
specchio classe VI (guardaruota anteriore)
espejo clase VI (retrovisor para parte frontal del vehículo)
spegelklass VI (frontspiegel)
zrcadlo třídy VI (zrcadlo čelní)
зеркало класс VI (фронтальное зеркало)
sinif VI ayna (ön tapın aynası)
VI tükürösztyly (fronttükör)
lustra klasy VI (przednie)

II + IV Spiegelsystem Klasse II + IV
(Hauptspiegel + Weitwinkelspiegel)
mirror system class II + IV
(main mirror + wide angle mirror)
système de rétroviseurs classe II + IV
(rétroviseur principal + rétroviseur grand angle)
espelho classe II + IV
(espelho principal + espelho auxiliar)
sistema di specchi classe II + IV
(retrovisore principale + coppa grandangolo)
sistema de retrovisores classe II + IV
(espejo principal + espejo de gran ángulo)
spiegelsystem klass II + IV
(huvudspegel + vidvinkelspegel)
systém zpětných zrcadel třídy II + IV
(zrcadlo hlavní + zrcadlo širokouhlé)
Система зеркал класс II + IV
(главное + широкоугольное зеркало)
sinif II + IV ayna sistemi
(ana ayna + geniş görüş aynası)
tükörrendszert II és IV osztályok tükörökkel
(fő és nagy látószögű tükörökkel)
system lusterek klasy II + IV
(głównie + szerokokątne)

II + V Spiegelsystem Klasse II + V
(Hauptspiegel + Rampenspiegel)
mirror system class II + V
(main mirror + roof mirror)
système de rétroviseurs classe II + V
(rétroviseur principal + miroir d'accostage)
espelho classe II + V
(espelho principal + espelho de rampa)
sistema di specchi classe II + V
(retrovisore principale + specchio guardaruota)
sistema de retrovisores classe II + V
(espejo principal + espejo de rampa)
spiegelsystem klass II + V
(huvudspegel + närskiktspegel)
systém zpětných zrcadel třídy II + V
(zrcadlo hlavní + zrcadlo rampové)
Система зеркал класс II + V
(главное + зеркало для рамы)
sinif II + V ayna sistemi
(ana ayna + kapı üstü aynası)
tükörrendszert II és V osztályok tükörökkel
(fő és rampa tükörökkel)
system lusterek klasy II + V
(głównie + rampowe)

ECE EG- / ECE - gerecht
according to EEC-norm
conforme aux normes / CE
conforme normas da CE
a norma CEE
conforme a las normas CE
EG-godkänd
splňuje normy EU
соответствует нормам ECE
ECC normárina uygun
EG / ECE -nek megfelelő
zgodne z EC / ECE

Katalogseite
catalogue page
page du catalogue
página do catálogo
pagina catalogo
página catálogo
Katalogside
strana katalogu
strаница каталога
katalog sayfasi
katalógus oldal
strona w katalogu

MEKRA Lang - **passion** for excellence.

Contents are subject to change
Last Update: March2026
www.mekra.de

